



LARGE HORIZONTAL MACHINING CENTER

HM

1000 • 1250 • 1250W



DN SOLUTIONS

HM 1000 • 1250 • 1250W

A twin pallet horizontal machining centre designed for processing large workpieces. A wide variety of machining applications can be carried out with the 1000/1250mm pallet size and optional W axis capability. The heavy duty box guideways, high torque gearbox spindle and minimum non-cutting time will provide users with a high level of productivity and added value.



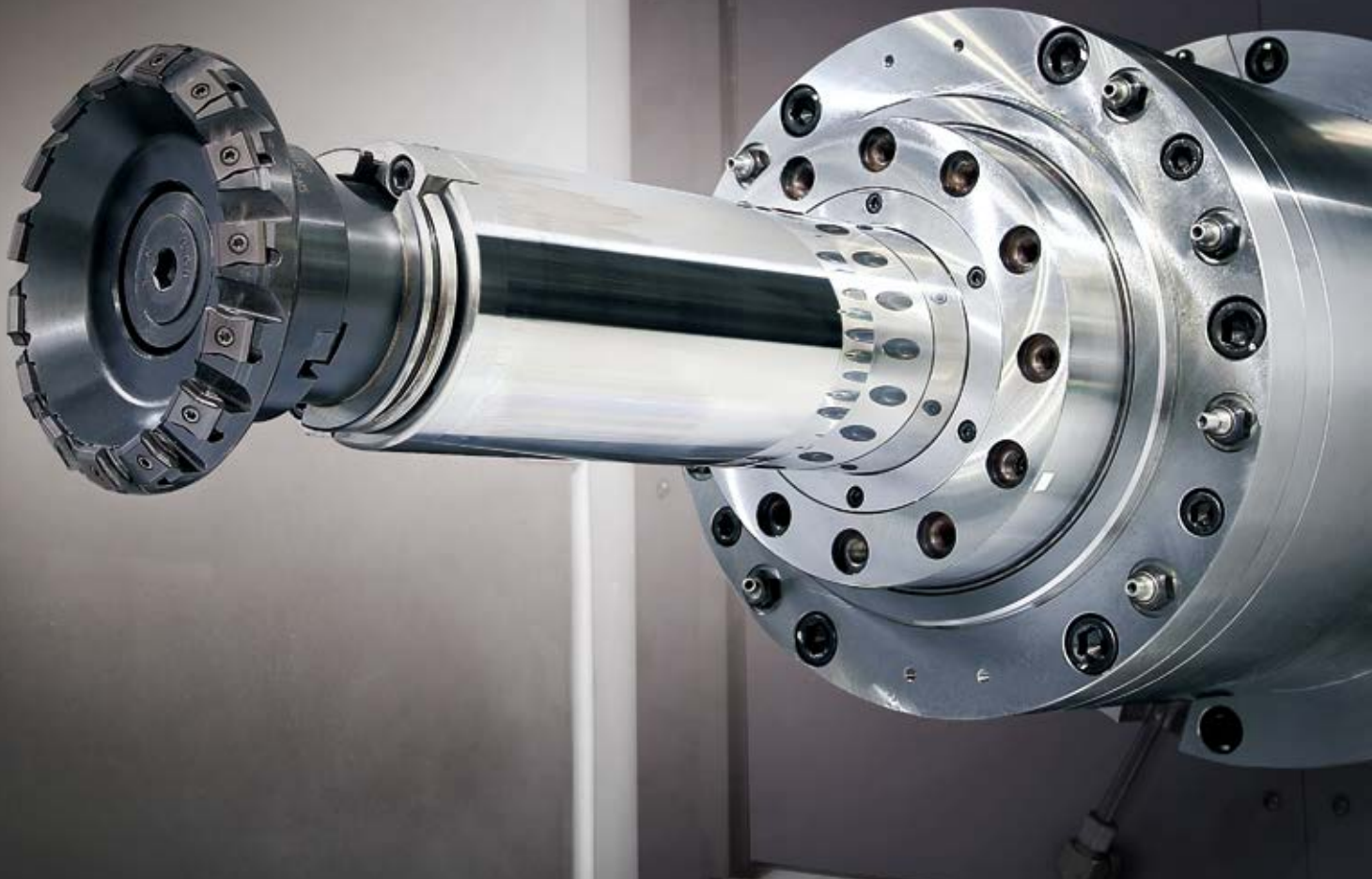

IMPROVED PRODUCTIVITY WITH HIGH PERFORMANCE SPECIFICATIONS

- High torque gearbox spindle, box-type guideways, and high rigidity cast structure achieves high productivity.

GENERAL TYPE AND OPTIONAL W AXIS APPLICATIONS

- A wide variety of large workpieces can be handled due to the machine's large capacity and optional W axis for long boring applications.

READY FOR AUTOMATION WITH STANDARD PALLET CHANGE SYSTEM

- The shuttle-type pallet changer satisfies the needs for long-term operation and automation.

BASIC STRUCTURE

High rigidity bed supports high accuracy.

Large Horizontal Machining Center

Designed for large workpieces requiring heavy duty cutting performance, the HM1000/1250/1250W offer the solution for various requirements.

Travel distance (X / Y / Z axis)

HM 1000

2100 / 1250 / 1250 mm

82.7 / 49.2 / 49.2 inch

HM 1200

2100 / 1500 / 1500 mm

82.7 / 59.1 / 59.1 inch

Travel distance (X / Y / Z / W axis)

HM 1250W

2100 / 1400 / 1400 / 300 mm

82.7 / 55.1 / 55.1 / 11.8 inch

Rapid traverse rate (X / Y / Z axis)

HM 1000 / HM 1250

24 / 24 / 24 m/min

944.9 / 944.9 / 944.9 ipm

Rapid traverse rate (X / Y / Z / W axis)

HM 1250W

24 / 24 / 24 / 6 m/min

944.9 / 944.9 / 944.9 / 236.2 ipm

* The HM1250W Y-axis is applied with roller LM guideway.



HM 1000 / 1250



HM 1250W

Stable High-rigidity Axis Structure

All the linear axes are driven by high precision preloaded ballscrews to minimise thermal error. They are coupled directly to the absolute-type servo motor to optimise accuracy.

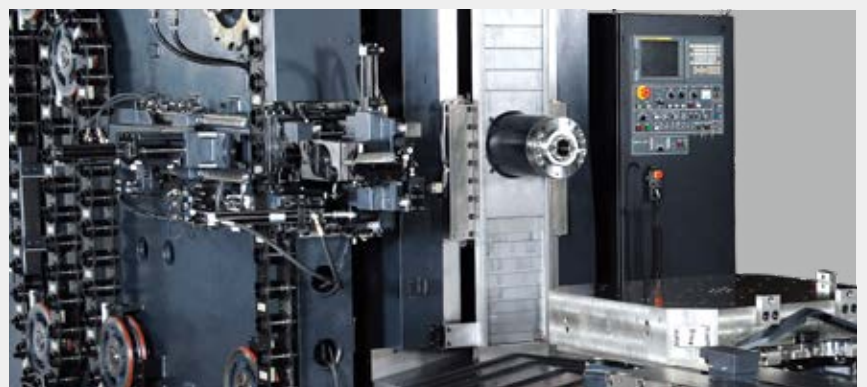

SPINDLE

Gearbox driven spindle realizes high productivity.

Gearbox Spindle

High torque spindle, dual contact tool system, and spindle cooling system adopted as standard realize high stability and reliability.

Max. spindle speed

HM 1000 / HM 1250

6000 r/min

6000 / 8000 r/min option

HM 1200W

3000 r/min



HM 1000 / 1250

Item	Unit	HM 1000 / 1250	HM 1250W
Max. spindle speed	r/min	6000 {6000, 8000}	3000
Spindle motor power (30min. / Cont.)	kW (Hp)	26 / 22 {37 / 30, 26 / 22} (34.9 / 29.5 {49.6 / 40.2, 34.9 / 29.5})	45 / 37 (60.3 / 49.6)
Max. spindle torque	N·m (ft·lb)	1989.4 {3687 / 1410} (1468.2 {2721.0 / 1040.6})	1910 (1409.6)

{ } : option

Spindle Cooling

Adopted as a standard feature, the oil cooler system minimizes thermal error over an extended time of operation the oil cooler system minimises thermal error over an extended period of operation.

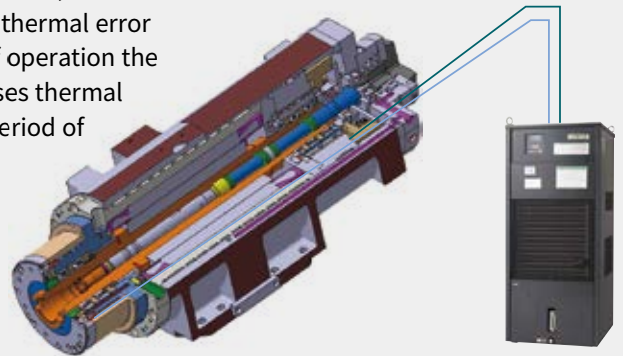

MAGAZINE

Reliability is further improved with the adoption of servo motors and the tool storage capacity can be extended up to 316 tools.

Tool-to-Tool (T-T-T)

HM 1000 / HM 1250

10 s

HM 1250W

12 s

Tool storage capacity

60 ea

90 / 120 / 196 / 256 /

316 ea option

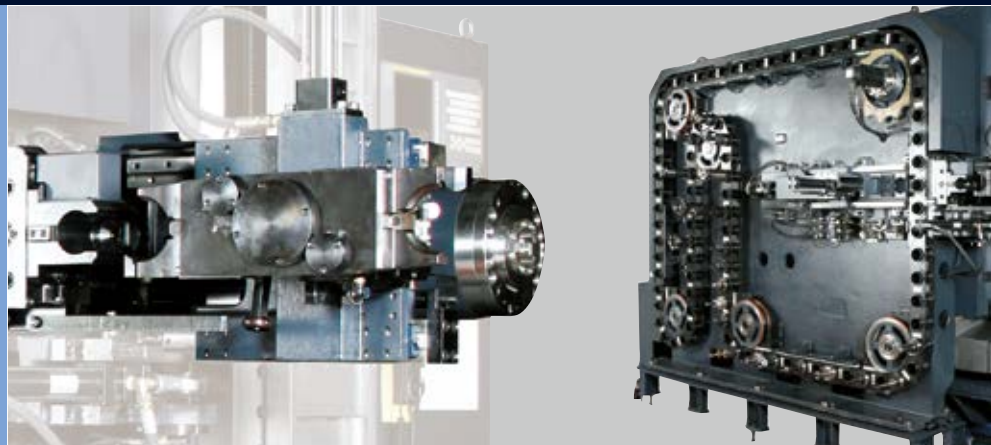

Item	Unit	HM 1000	HM 1250	HM 1250W
Tool storage capacity	ea	60 {90 / 120, 196 / 256 / 316 (MATRIX)}		
Tool-to-Tool	sec	10		12
Max. tool diameter (Neighboring pot empty)	mm (inch)	130 (300) (5.1 (11.8))		
Max. tool length	mm (inch)	650 (25.6)	650 {800*} (25.6 {31.5'})	700 (27.6)
Max. tool weight	kg (lb)	30 (66.1)		

* In case of HM 1250 with Max. Workpiece diameter 2000 mm spec.

TABLE | CUTTING PERFORMANCE

The table capacity is suitable for large workpieces .

Pallet size

HM 1000

1000 x 1000 mm
39.4 x 39.4 inch

1250 x 1000 mm option
49.2 x 39.4 inch

HM 1250 / HM 1200W

1250 x 1250 mm
49.2 x 49.2 inch

1250 x 1000 mm option
49.2 x 39.4 inch

Max. work size

HM 1000

2000 x 1475 mm
78.7 x 58.1 inch

HM 1250 / HM 1200W

2000 x 1725 mm
18.7 x 67.9 inch

2300 x 1725 mm option
90.6 x 67.9 inch

Loading capacity

HM 1000 / HM 1250

3000 kg 6613.8 lb
5000 kg 11023.0 lb option

HM 1200W

5000 kg 11023.0 lb

The shuttle-type, automatic pallet changer as standard specification improves productivity.

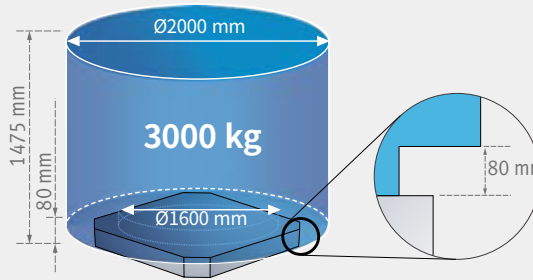

Machining Performance

HM 1250W

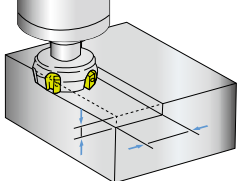
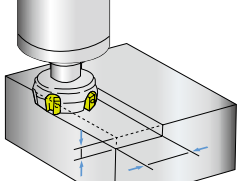
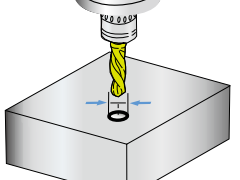
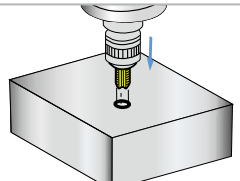
Face mill (material : SM45C / W-axis : 300 mm (11.8 inch))						
Tool mm (inch)	Spindle speed r/min	Feed rate mm/min (ipm)	Cutting width mm (inch)	Cutting depth mm (inch)	Chip removal rate cm ³ /min (inch ³)	
D125	360	300 (11.8)	80 (3.1)	1.7 (0.067)	40.8 (2.5)	
Face mill (material : SM45C / W-axis : 0 mm (0 inch))						
Tool mm (inch)	Spindle speed r/min	Feed rate mm/min (ipm)	Cutting width mm (inch)	Cutting depth mm (inch)	Chip removal rate cm ³ /min (inch ³)	
D125	300	1680 (66.1)	100 (3.9)	7 (0.3)	1176 (71.8)	
	300	1400 (55.1)	100 (3.9)	8 (0.3)	1120 (68.3)	
	300	1300 (51.2)	100 (3.9)	9 (0.4)	1170 (71.4)	
U-drill						
Tool mm (inch)	Spindle speed r/min	Feed rate mm/min (ipm)	Cutting depth mm (inch)			
D85 (D3.3)	560	165 (6.5)	50 (2.0)			
D120 (4.7)	380	77 (3.0)	50 (2.0)			
Tap						
Tool mm (inch)	Spindle speed r/min	Feed rate mm/min (ipm)	Cutting depth mm (inch)			
M48 x 5 (M1.9 x 0.2)	100	500 (19.7)	45 (1.8)			

STANDARD | OPTIONAL SPECIFICATIONS

A range of options is available to suit individual requirements.

Description	Features	HM 1000	HM 1250	HM 1250W
PALLET TYPE	0.001 DEGREE	○	○	○
	1 DEGREE	●	●	●
NO. OF PALLETS	2 EA	●	●	●
	2 EA + 1 SPARE PALLET	○	○	○
	2 EA + 2 SPARE PALLETS	○	○	○
	2 EA + 3 SPARE PALLETS	○	○	○
	2 EA + 4 SPARE PALLETS	○	○	○
	6 PALLETS MAGAZINE STATION - PMG	○	○	○
PALLET CHECK SYSTEM	AIR LIMIT SENSING	○	○	○
PALLET SIZE	1000 X 1000 MM	●	○	○
	1250 X 1000 MM	○	○	○
	1250 X 1250 MM	X	●	●
REFERENCE OF WORKPIECE SETTING	CENTER BUSH	○	○	○
TOOL STORAGE CAPACITY	120 EA	○	○	○
	196 EA	○	○	○
	60 EA	●	●	●
	90 EA	○	○	○
AUTO TOOL MEASURING DEVICE	ENCODER NEEDLE TYPE_BK MIKRO	○	○	○
	OMRON LIMIT SWITCH TYPE	○	○	○
	RMI-Q_ONLY_RENISHAW	○	○	○
	TS27R_RENISHAW	○	○	○
AIR	AIR BLOWER	○	○	X
	AIR GUN	○	○	○
OIL SKIMMER	BELT TYPE	○	○	○
COOLANT	COOLANT GUN	○	○	○
	SHOWER COOLANT	○	○	○
THROUGH SPINDLE COOLANT	1.5 kW_2.0 MPA	○	○	○
	1.5 kW_2.0 MPA_CYCLON FILTER	○	○	○
	1.5 kW_3.0 MPA_COOLJET BAG FIL	○	○	○
	3.7 kW_7.0 MPA_BAG FILTER	○	○	○
	3.7 kW_7.0MPA_PAPER ROLL FILTER	○	○	○
	4.0 kW_2.0 MPA	○	○	○
	3.0 kW_3.0 MPA_CYCLON FILTER	○	○	○
	5.5 kW_7.0 MPA_DUAL BAG FILTER	○	○	○
7.5 kW_7.0 MPA_CYCLON FILTER	○	○	○	
AUTO WORKPIECE MEASURING DEVICE	OMP60_RENISHAW	○	○	○
	RMP60_RENISHAW	○	○	○
CALIBRATION BLOCK	CALIBRATION BLOCK	○	○	○
CHIP CONVEYOR	FORKLIFT_380L	○	○	○
	ROTATION_380L	○	○	○
	HINGED BELT_LEFT SIDE	○	○	○
	MAGNETIC SCRAPER_LEFT SIDE	○	○	○
LINEAR SCALE (X/Y/Z AXIS)	ABSOLUTE PULSE CODER	○	○	○
MIST COLLECTOR	2.2 KW_NONE WATER SOLUBLE	○	○	○
	2.2 KW_WATER SOLUBLE	○	○	○
SAFETY SENSOR FOR OPERATOR	ARRAY SENSOR	○	○	○
TEST BAR	TEST BAR GAUGE	○	○	○
WORK LOCATING CONFIRMATION	AIR LIMIT SENSING_2 PORT	○	○	○
AIR CONDITIONER	AIR CONDITIONER	○	○	○
AUTOMATIC POWER OFF	AUTOMATIC POWER OFF	○	○	○
AUTOMATIC POWER ON	AUTOMATIC POWER ON	○	○	○
ELECTRIC CABINET LIGHT	ELECTRIC CABINET LIGHT	○	○	○
FASTEMS FMS INTERFACE	FASTEMS FMS INTERFACE	○	○	○
MPG	3 MPG_PORTABLE TYPE	○	○	○
CUSTOMIZED SPECIAL OPTION	SINGLE PALLET	○	○	○
	HYD. FIXTURE 2X2	○	○	○
	X, Z AXIS SLIDE COVER CHIP FLUSHING	○	○	○
	TOOL LENGTH 800MM	X	○	X
	AUTO DOOR HEIGHT (1725mm → 2000mm)	X	○	X
	15K SPINDLE HEAD	X	○	X

*Please contact DN Solutions for detailed specifications.

● Standard ○ Optional x Not applicable

PERIPHERAL EQUIPMENT

Chip Conveyor



Measurement Systems

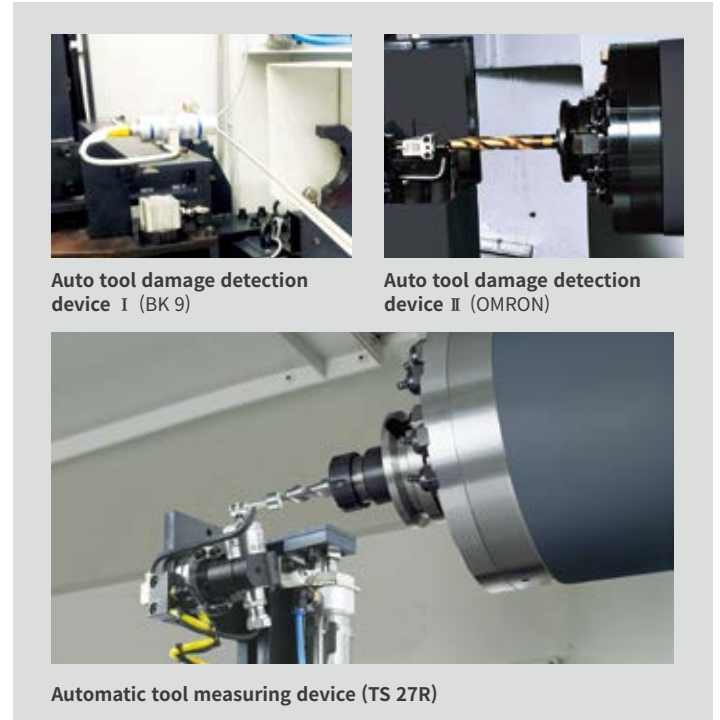

Environment Friendly Devices

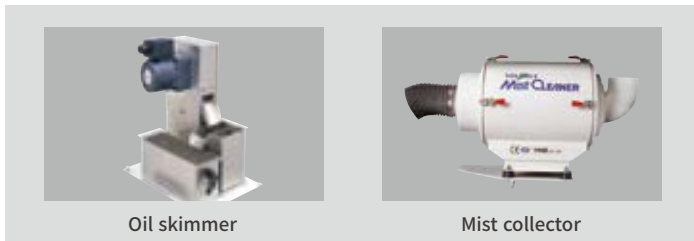

Cutting Oil Cooling System

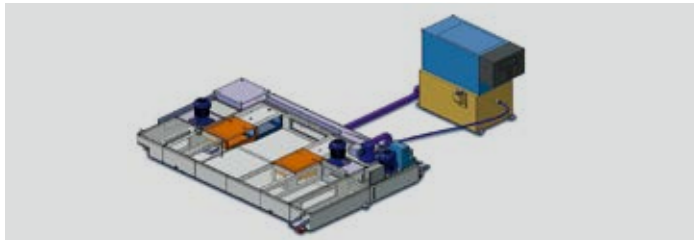

Linear Scale Feedback System



Chip Disposal System



MULTI PALLET SYSTEM

PMG (Pallet Magazine)

The PMG system is composed of a rotating pallet pool storage unit and a feed mechanism to transfer the pallet to and from the machine working area. In addition, a pallet can be transferred to a separate setup station where the operator has allround access for loading the workpiece.

Features

- Conventional multi pallet changer round type
- Available large volume workpiece
- Driven by hydraulic unit
- Stable pallet changing unit
- Pallet scheduling operation (1-Path, PMC control)

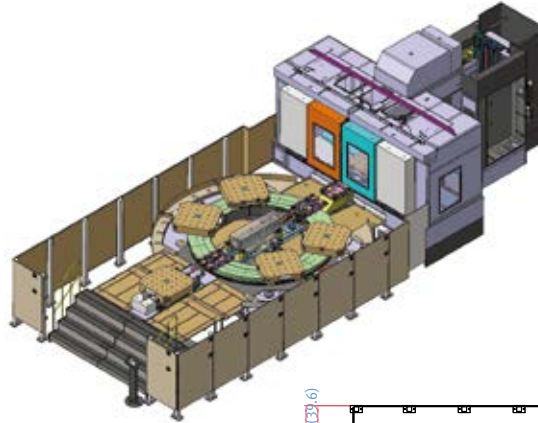

External Dimensions

Unit : mm (inch)

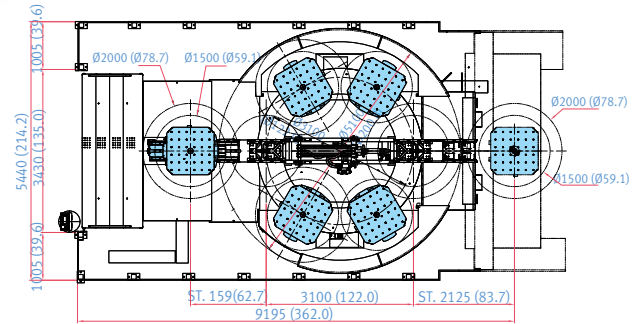

Available Model		HM 1000	HM 1250	HM 1250W
Pallet Dimension	mm (inch)	1000 x 1000 (39.4 x 39.4), 1250 x 1000 (49.2 x 39.4)		
Workpiece Diameter	mm (inch)	1500 (59.1) {2000 (78.7), closed pallet need to be empty}		
Workpiece Height	mm (inch)	1475 (58.1)	1725 (67.9)	
Workpiece Weight	kg (lb)	3000 (6613.8)		
Magazine type		Round type		
Operation		Pallet scheduling operation (1-Path, PMC control)		
Pallet Drive Device		HYDRAULIC MOTOR & CHAIN		
Hydraulic Power Unit	kW (Hp)	7.5 (10.1)		

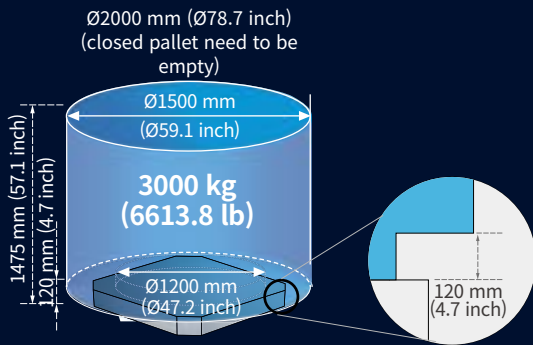

Single pallet system

Space can be reduced by Single-pallet system.

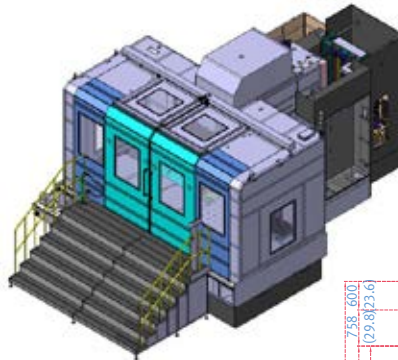

External Dimensions

Unit : mm (inch)

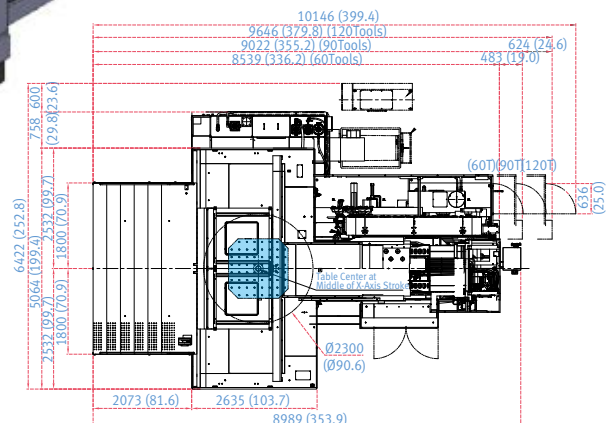

Description	HM 1000	HM 1250	HM 1250W
Max work-piece size	mm (inch)	2000 x 1475 (78.7 x 58.1)	2300 x 1725

* This layout is for HM1250 Single pallet

FANUC 31i/32i PLUS

Fanuc 31i/32i Plus maximizes customer productivity and convenience.

15" Touch screen + New OP

DN Solutions Fanuc 31iB/B5 Plus' operation panel enhances operating convenience by incorporating common-design buttons and layout. It features a Qwerty keyboard for fast and easy data input and operation.

Fanuc 31i/32i Plus

- 15-inch color display
- Intuitive and user-friendly design

USB and PCMCIA card QWERTY keyboard

- EZ-Guide i standard
- Ergonomic operator panel
- 4MB Memory
- Hot keys
- Enhance AICC BLOCK
- Touch pen provided as standard



iHMI touchscreen

iHMI provides an intuitive interface that uses a touchscreen for quick and easy operation.

Range of applications

Providing various applications related to planning, machining, improvement and utility, for customer convenience.

NUMERIC CONTROL SPECIFICATIONS

FANUC

	Item	Specifications	F31iB PLUS	
			HM1000 / HM1250 / HM1250W	
Controlled axis	Controlled axes		4 (X,Y,Z,B)	
	Simultaneously controlled axes		4 axes	
	Additional controlled Axis	Add 1 Axis (5th Axis)	●	
Data input/output	Fast data server		○	
	Memory card input/output		●	
	USB memory input/output		●	
	Large capacity memory(2GB)*2	Note *2) Available Option only with 15" Touch LCD (iHMI Only)	○	
Interface function	Embedded Ethernet		●	
	Fast Ethernet		○	
	Enhanced Embedded Ethernet function		●	
Operation	DNC operation	Included in RS232C interface.	●	
	DNC operation with memory card		●	
Program input	Workpiece coordinate system	G52 - G59	●	
	Addition of workpiece coordinate system	G54.1 P1 X 48 (48 pairs)	●	
	Tool number command		●	
Feed function	Tilted working plane indexing command	G68.2 TWP	○	
	AI contour control I	G5.1 Q_, 40 Blocks	X	
	AI contour control II	G5.1 Q_, 200 Blocks	X	
	AI contour control II	G5.1 Q_, 600 Blocks	●*	
	AI contour control II	G5.1 Q_, 1000 Blocks	○*	
Operation Guidance Function	High smooth TCP		X	
	EZ Guidei (Conversational Programming Solution)		●	
	iHMI with Machining Cycle	Note *1) Only with 15" Touch LCD standard	●	
Setting and display	EZ Operation package		●	
	CNC screen dual display function		●	
Network	FANUC MT Connect		⊗	
	FANUC OPC UA		⊗	
Others	Display unit	15" color LCD	X	
		15" color LCD with Touch Panel	●	
		640M(256KB) _500 programs	X	
		1280M(512KB) _1000 programs	X	
		2560M(1MB) _1000 programs	X	
		5120M(2MB) _1000 programs	X	
		10240M(4MB) _1000 programs	●	
		20480M(8MB) _1000 programs	○	
		2560M(1MB) _2000 programs	○	
		5120M(2MB) _4000 programs	○	
	10240M(4MB) _4000 programs	○		
20480M(8MB) _4000 programs	○			
Part program storage size & Number of registerable programs				

EZ WORK

The software developed by DN Solutions features numerous functions designed for convenience and ease of operation.

EZ work

The EZ work package delivers speed and efficiency. This menu-driven innovation not only helps customers reduce setup times, but also simplifies common tasks and procedures, reducing the potential for errors. EZ work reduces operating time, protects machinery, enhances quality and speeds up maintenance interventions.

Tool support functions



Tool management I

- Tool magazine control
- Tool state display
- Fastems Tool Add/Remove Function option



Tool management II option

- Tool magazine control
- Tool life management
- Tool life prediction
- Tool state control
- Balluff Tool ID function

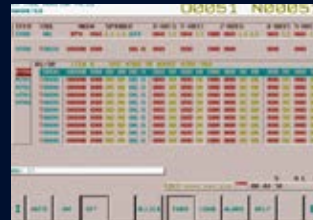

Tool load monitor option

- Detection of tool damage
- Detection of abnormalities during operation
- Detection of no-load air cutting

Productivity improvement functions



Adaptive Feed Control

Function to control feedrate so that the cutting can be carried out at a constant load



APC Setting Screen

A simple automation function that supports automatic processing of the next pallet by setting the processing program for each pallet of the equipment including APC in advance



PMC Soft Panel Switch

Manual operations that occur continuously in each stages for APC,ATC change command

Operation support, Help desk functions



Operation rate

- Measure various machine operating rate
- Support 3 shift operation
- calculate and save 30 days operating rate
- Show data for a specific period

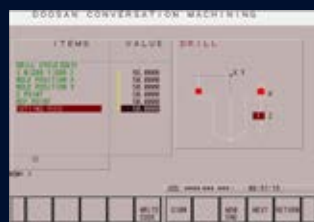

Pattern Cycle

A function to automatically create frequently used part programs.



Renishaw GUI

Renishaw tool length measuring and compensate function



Spindle Warm Up

A function that assists spindle warm-up for spindle life when the spindle has not been used for a certain period of time

POWER | TORQUE

HM 1000 / 1250

6000 r/min

Spindle motor power: **26 / 22 kW**
34.9 / 29.5 Hp

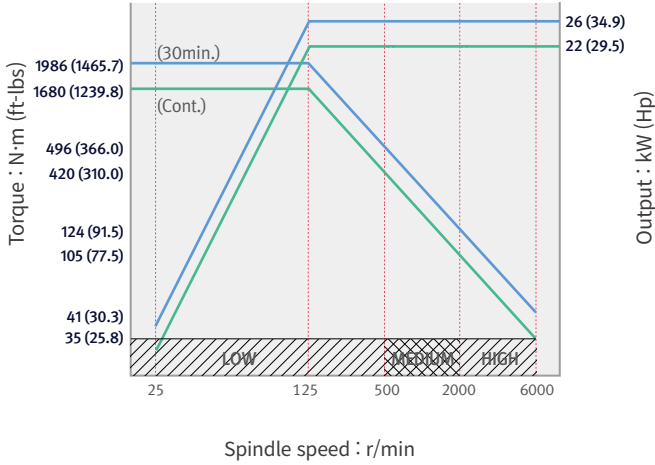

6000 r/min option

Spindle motor power: **37 / 30 kW**
49.6 / 40.2 Hp

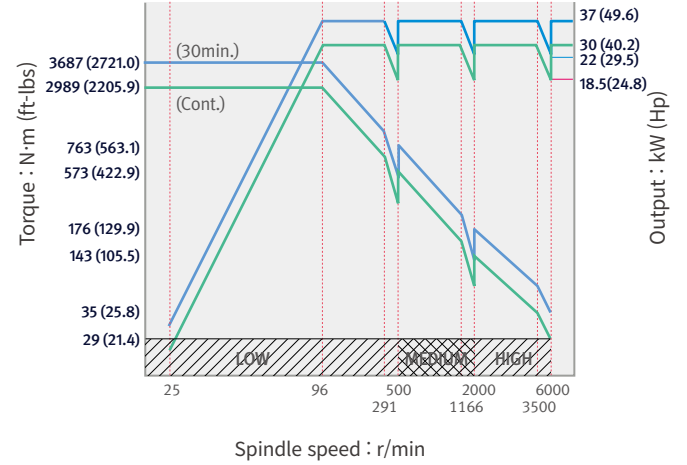

8000 r/min option

Spindle motor power: **26 / 22 kW**
34.9 / 29.5 Hp

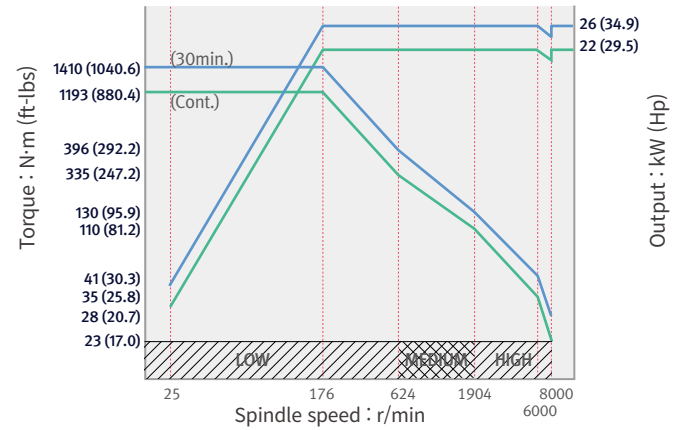

HM 1250W

3000 r/min

Spindle motor power: **45 / 37 kW** (30min. / Cont.)
60.3 / 49.6 Hp

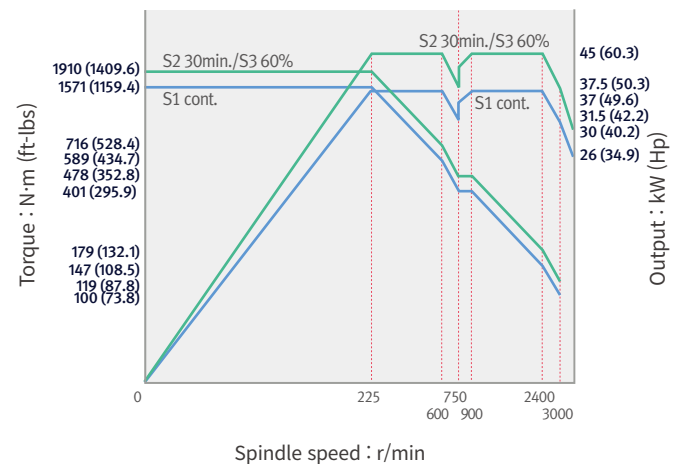

DIMENSIONS

Units : mm (inch)

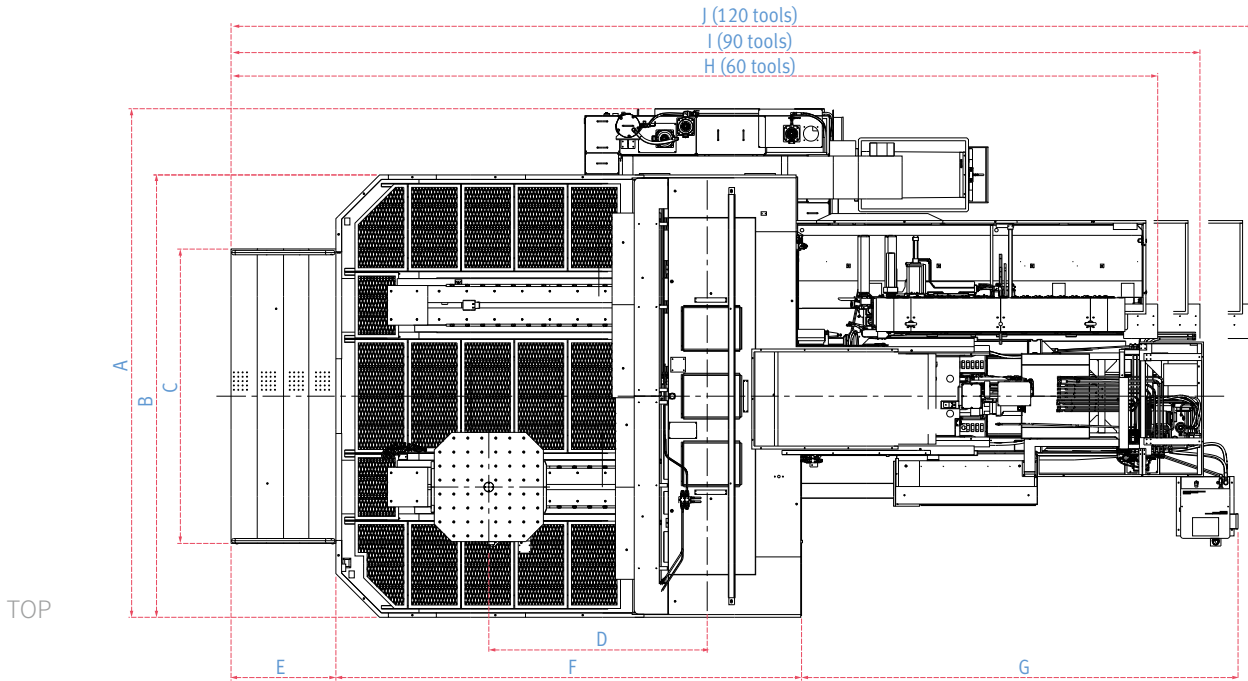

Model	A	B	C	D	E	F	G	H	I	J
HM 1000	5822 (229.2)	5064 (199.4)	3370 (132.7)	2100 (82.7)	1162 (45.7)	4780 (188.2)	3715 (146.3)	9928 (390.9)	10411 (409.9)	11035 (434.4)
HM 1250	5822 (229.2)	5064 (199.4)	3370 (132.7)	2500 (98.4)	1200 (47.2)	5330 (209.8)	4000 (157.5)	10530 (414.6)	11000 (433.1)	11623 (457.6)
HM 1250W	5822 (229.2)	5064 (199.4)	3370 (132.7)	2500 (98.4)	1200 (47.2)	5330 (209.8)	4996 (196.7)	10606 (417.6)	11089 (436.6)	11713 (461.1)

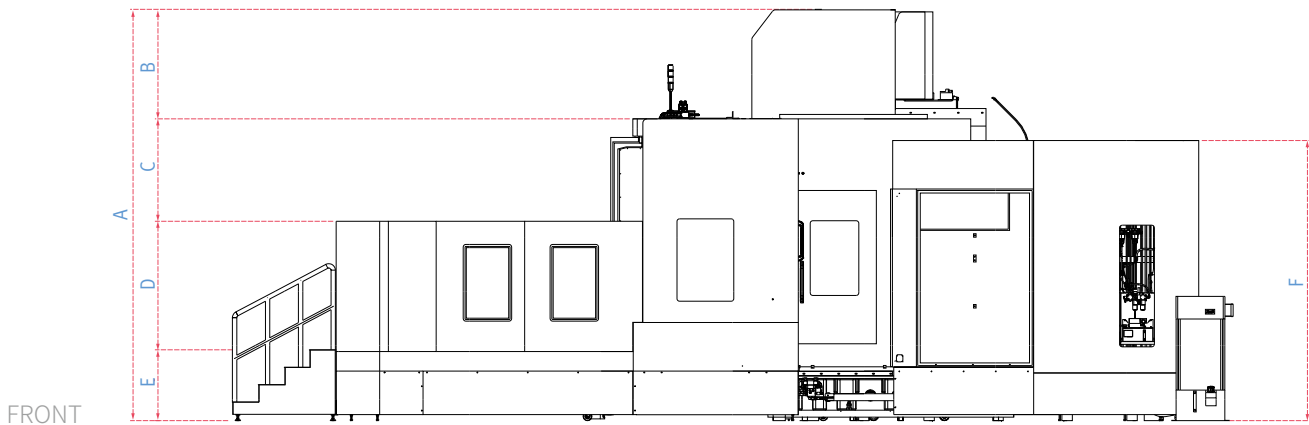

Model	A	B	C	D	E	F
HM 1000	3885 (153.0)	660 (26.0)	929 (36.6)	1493 (58.8)	803 (31.6)	3225 (127.0)
HM 1250	4130 (162.6)	660 (26.0)	1179 (46.4)	1493 (58.8)	803 (31.6)	3225 (127.0)
HM 1250W	4581 (180.4)	1106 (43.5)	1179 (46.4)	1481 (58.3)	815 (32.1)	3225 (127.0)

* Some peripheral equipment can be placed in other places

TABLE DIMENSIONS | TOOL SHANK

Table dimensions

Units : mm (inch)

TAP PALLET

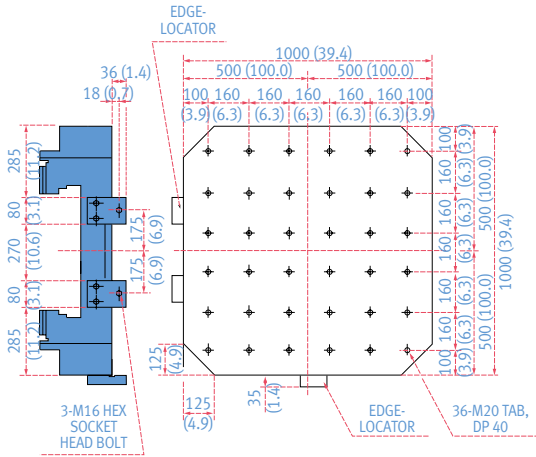

T - SLOT PALLET option

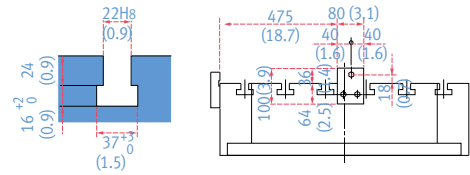
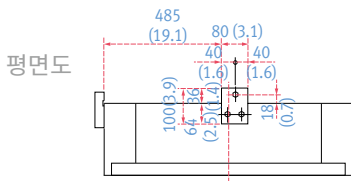
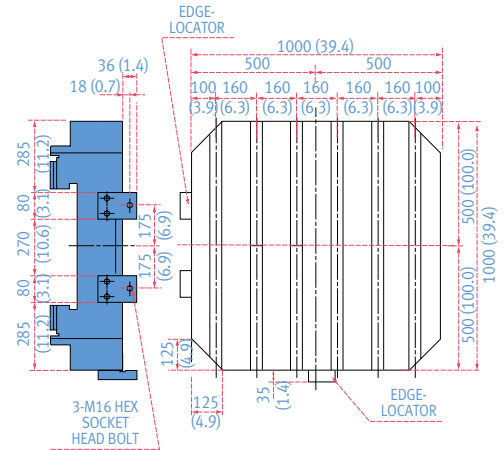

◀ HOLE DETAIL ▶

Tool Shank

Units : mm (inch)

BT 50

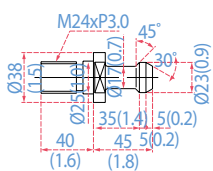
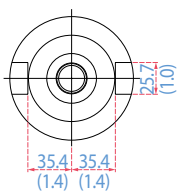
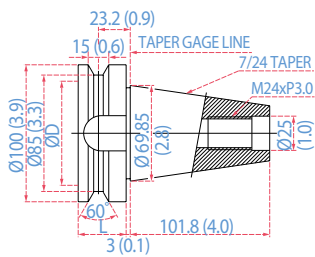

CAT 50

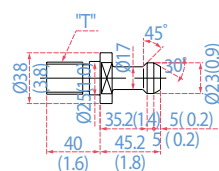
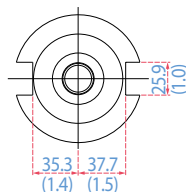
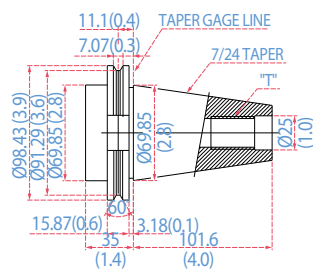

DIN 50

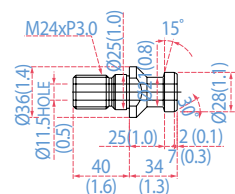
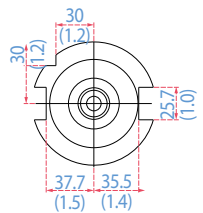
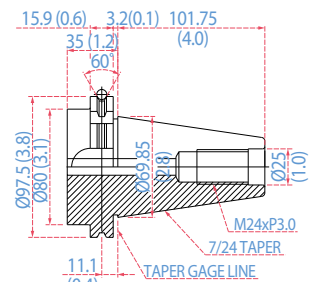

MACHINE SPECIFICATIONS

Description		Unit	HM 1000	HM 1250	HM 1250W
Travels	X-axis	mm (inch)	2100 (82.7)		
	Y-axis	mm (inch)	1250 (49.2)	1500 (59.1)	1400 (55.1)
	Z-axis	mm (inch)	1250 (49.2)	1500 (59.1)	1400 (55.1)
	W-axis	mm (inch)	-	-	300 (11.8)
Table	Distance from table top to spindle nose	mm (inch)	75 ~ 1325 (3.0 ~ 52.2)	50 ~ 1550 (2.0 ~ 61.0)	50 ~ 1450 (2.0 ~ 57.1)
	Table size	mm (inch)	1000 x 1000 {1250 x 1000} (39.4 x 39.4 {49.2 x 39.4})	1250 x 1250 {1250 x 1000} (49.2 x 49.2 {49.2 x 39.4})	
	Loading capacity	kg (lb)	3000 {5000} (6613.8 {11023.0})		5000 (11023.0)
	Table type	-	36-M20 x P2.5 {44-M20 x P2.5}	60-M2 x P2.5 {44-M20 x P2.5/ 36- M20 x P2.5}	
	Max. workpiece size (Ø x H)	mm (inch)	2000 X 1475 (78.7 X 58.1)		
Spindle	Max. spindle speed	r/min	6000 {6000 / 8000}		3000
	Taper	-	ISO #50, 7/24		
	Max. spindle torque	N·m (ft-lb)	1989.4 {3687 / 1410} (1468.2 {2721.0 / 1040.6})		1910 (1409.6)
	Spindle motor power	kW (Hp)	26 / 22 {37 / 30, 26 / 22} (34.9 / 29.5 {49.6 / 40.2, 34.9 / 29.5})		45 / 37 (60.3 / 49.6)
Feedrate	Rapid traverse rate (X/Y/Z/W)	m/min (ipm)	24 / 24 / 24 (944.9 / 944.9 / 944.9)		24 / 24 / 24 / 6 (944.9 / 944.9 / 944.9 / 236.2)
	Cutting feedrate	mm/min (ipm)	12000 (472.4)		
ATC	Type of tool shank	-	BT / CAT / DIN 50		
	Tool storage capacity	ea	60 {90 / 120 / 196 / 256 / 316}		
	Max. tool diameter (Neighboring pot empty)	mm (inch)	130 (300) (5.1(11.8))		
	Max. tool length	mm (inch)	650 (25.6)	650 {800*} (25.6 {31.5*})	700 (27.6)
	Max. tool weight	kg (lb)	30 (66.1)		
	Max. tool moment	N·m (ft-lb)	34.3 (25.3)		
	Method of tool selection	-	Fixed address		
	Tool change time (Tool-To-Tool)	sec	10		12
Machine Dimensions	Length x Width	mm (inch)	9657 x 5822 (380.2 / 229.2)	10530 x 5822 (414.6 / 229.2)	11526 x 5822 (453.8 / 229.2)
	Height	mm (inch)	3885 (153.0)	4130 (162.6)	4581 (180.4)
	Weight	kg (lb)	29000 (63933.1)	31000 (68342.3)	33000 (72751.5)
CNC	NC system	-	FANUC 31i Plus		
Power source	Electric power	kVA	71 {82, 68.5}		90

{ } : Option

* In case of HM 1250 with Max. Workpiece diameter 2000 mm spec.



dn-solutions.com

Head Office

22F T Tower, 30, Sowol-ro 2-gil
Jung-gu, Seoul, Korea, 04637

Tel: +82-2-6972-0370/0350
Fax: +82-2-6972-0400

DN Solutions America

19A Chapin Road, Pine Brook
New Jersey 07058, United States

Tel: +1-973-618-2500
Fax: +1-973-618-2501

DN Solutions Europe

Emdener Strasse 24, D-41540
Dormagen, Germany

Tel: +49-2133-5067-100
Fax: +49-2133-5067-111

DN Solutions India

No.82, Jakkuar Village
Yelahanka Hobli, Bangalore-560064

Tel: + 91-80-2205-6900
E-mail: india@dncompany.com

DN Solutions China

Room 101,201,301, Building 39 Xinzhuan
Highway No.258 Songjiang District
China Shanghai (201612)

Tel: +86 21-5445-1155
Fax: +86 21-6405-1472

Sales inquiry

sales@dncompany.com

* For more details, please contact DN Solutions.

* Specifications and information contained within this catalogue may be changed without prior notice.