



HIGH PRODUCTIVITY VERTICAL TURNING CENTER

PV

8300/M/2SP/M-2SP • **9300/M/2SP/M-2SP**



DN SOLUTIONS

PV 8300/9300 SERIES

The new PV 8300/9300 Series comprises a range of 15"~32" chuck size vertical turning centers developed by DN Solutions using the latest technologies. The column-integrated box guideway and reinforced bed frame machines have a stronger and more rigid structure that is suitable for heavy-duty turning. The Series represents the largest turning capacity of its class further enhancing productivity and profitability.





PV 9300M



PV 9300M (ATC OPTION)

ENHANCED MACHINING CAPACITY

The largest turning capacity in its class is achieved with max. 32" m chuck size and 930 mm (36.6 inch) of max. turning diameter.

HIGHEST POWER AND MACHINING PERFORMANCE IN ITS CLASS

- High power spindle for powerful cutting performance
 - Max. power 45kW, torque 4443N · m (PV 9300)
 - Max. power 45kW, torque 3153N · m (PV8300) OPTION
- Increase the number of tools with ATC option can improve the flexibility and efficiency of machining performance
- Fast and stable servo driven turret
- Robust BMT milling holder on turret and best-in-class high power rotary tool motor carry out high productivity in milling <M type model>

IMPROVED OPERATIONAL EFFICIENCY, INCLUDES IMPROVED CHIP DISPOSAL AND OPERATION PANEL

- Highly steep bed structure for easy chip disposal
- Intuitive and user-friendly DN Solutions FANUC i PLUS CNC
- Pendant type operation panel with easy movement of locating and height adjustment according to operator's workflow

BASIC STRUCTURE

The integral box guideway bed design delivers vibration-free performance and ensures heavy duty and high precision cutting over long periods of operation.

The machine frame and structure have been redesigned to accommodate the enhanced specifications. The rapid traverse is increased to 20 m/min (787.4 ipm) for higher productivity.

Travel distance

PV 8300

X-axis **495(-80~415)** mm
19.5(-3.1~16.3) inch

Z-axis **780** mm
30.7 inch

PV 9300

X-axis **485(-20~465)** mm
19.1(-0.8~18.3) inch

Z-axis **890** mm
35.0 inch

Rapid traverse rate

X/Z-axis **20** m/min
787.4 ipm



MACHINING AREA

Wider machining area for larger/more diverse workpieces.

Wider machining area

The turning center now offers larger turning diameter and swing of workpiece.

Max. turning diameter

PV 8300/9300

Ø 830/Ø930 mm
Ø32.7/Ø36.6 inch

Max. turning height

* PV 8300 M

PV 8300/9300

780(690*)/801 mm
30.7(27.2)/31.5 inch

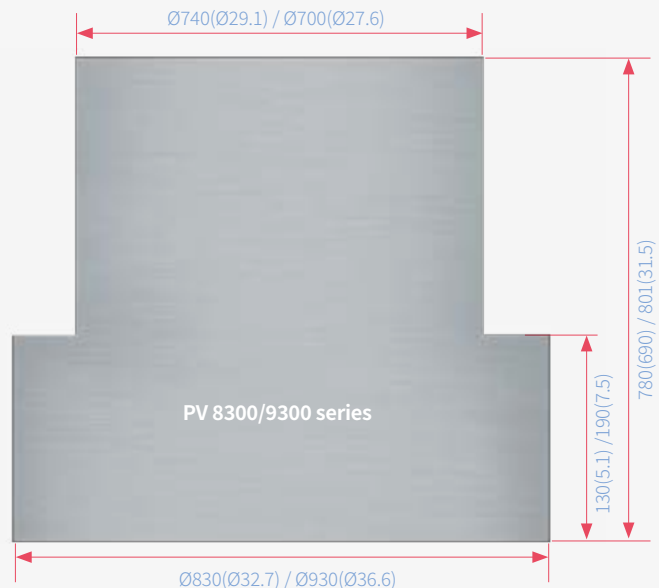

Chuck size

PV 8300

15 {18/21/24 OPTION } inch

PV 9300

24 {32 OPTION } inch

SPINDLE

Higher reliability and rigidity with improved base and spindle motor assembly.

Stronger spindle

The highly rigid gearbox structure provides the highest power / torque in its class for heavy duty cutting and optimum performance. A variety of spindle specifications are available to suit customers' diverse requirements.

Max. rotating speed

PV 8300/9300

2000/1800 r/min

Max. power (S6 40% / Cont.)

PV 9300

45 kW

Max. torque

PV 9300

4443 N.m



Description		Unit	PV 8300	PV 8300 M	PV 9300/M
Standard spindle (Gear box)	Power	kW (Hp)	37/30/22 (49.6/40.2/29.5) (S6 25%/S6 60%/S1 Cont.)	30/22 (40.2/29.5) (S6 60%/ S1 Cont.)	45/37 (60.3/49.6) (S3 60%/cont.)
	Max. torque	N · m (ft-lbs)	1659(1224.3)	1611(1188.9)	4443(3278.9)
Option 1 (Gear box)	Power	kW (Hp)	37/30(49.6/40.2) (S6 40%/S1 Cont.)		
	Max. torque	N · m (ft-lbs)	2592(1912.9)		
Option 2*	Power	kW (Hp)	45/37(60.3/49.6) (S6 40%/S1 Cont.)		
	Max. torque	N · m (ft-lbs)	3153(23286.1)		
SIEMENS	Power	kW (Hp)	42/32/28 (56.3/42.9/37.5)		
	Max. torque	N · m (ft-lbs)	3376(2491.5)		
Spindle nose		ASA	A2-11		A2-15
C-axis minimum rotation command angle (M type)		deg	0.001		

* C axis contouring control is available on option2

TURRET

The new servo turret facilitates faster indexing and accurate positioning.

Fast and accurate turret

The new servo motor turret increases indexing speed and accuracy. The M model has the BMT75P(P8300), BMT85P(P9300) turret that provides excellent milling performance and reduced thermal error due to its low heat generation design.

No. of tool positions

12 {8*/10*^{OPTION}} st

Turret indexing time

0.25 sec.

2-axis Turret



Turning/Milling(3-axis) turret

Rotary tool max. speed

PV 8300

BMT75P

PV 9300

BMT85P

Rotary tool max. power

PV 8300

18.5 kW/**118** N.m
24.8 Hp/87.1 ft-lbs

PV 9300

23 kW/**146** N.m
30.8 Hp/107.7 ft-lbs



CUTTING PERFORMANCE

Enable customers to cut large diameter workpieces and complete milling, drilling and tapping operations in a single setup.

O.D turning (Dia. Ø 446 mm (Ø17.6 inch))	PV 8300	PV 9300
Cutting speed (m/min (ipm))	210(8267.7)	
Feed (mm/rev (ipr))	0.55(0.0)	
Spindle speed (r/min)	965	97
Cutting depth (mm (inch))	4.5(0.2)	12(0.5)
I.D turning (Rough)	PV 8300	PV 9300
Cutting speed (m/min (ipm))	280 11023.6	
Feed (mm/rev (ipr))	0.3(0.0)	
Cutting depth (mm (inch))	3.0(0.1)	
Tool length (length/dia)	3.5D	
I.D turning (End)	PV 8300	PV 9300
Cutting speed (m/min (ipm))	200(7874.0)	
Feed (mm/rev (ipr))	0.1(0.0)	
Cutting depth (mm (inch))	0.1(0.0)	
Tool length (length/dia)	4.0D	

37/30 kW (49.6/40.2 Hp) spindle motor

* The above data is based on test machining results for SM45C material in accordance with DN Solutions's standard, and is subject to change without prior notice.



CHIP DISPOSAL

Improved chip disposal system increase the convenience of operation and maintenance for chip disposal even when applying various automation application.

Improved bed structure for easier chip disposal

A greater inclined slope results in improved chip removal from the working area, and a wider chip exit is able to handle higher chip volumes.

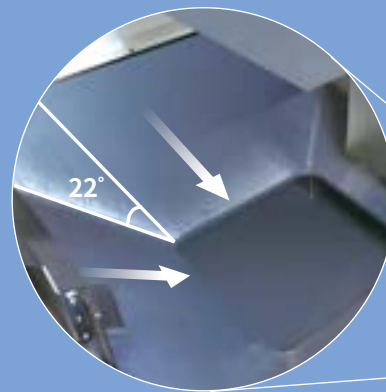

AUTOMATIC TOOL CHANGER(ATC) OPTION

Increasing the number of tools with ATC option can improve the flexibility and efficiency of machine operation or automation, especially it is advantageous to avoid interference with adjacent tools during long boring machining and minimize downtime for tool change when changing workpieces



Description	Unit	PV 8300	PV 9300	
			Type 1	Type 2
Tool shank	-	CAPTO C6	CAPTO C8	
Tool storage capacity	ea	12	8	
Max. tool diameter	mm (inch)	90 (3.5)		
Max. tool length	mm (inch)	375(14.8)	410(16.1)	
Max. tool mass	kg (lb)	10(22.0)	15(33.1)	
Tool search time(1 port)	sec	0.5		
No. of CAPTO tool holder on turret	ea	1~12		

* Please contact DN Solutions for detailed ATC specifications.

STANDARD | OPTIONAL SPECIFICATIONS

Diverse optional features are available for customer-specific work applications.

Description	Features	PV V 8300 series	PV V 9300 series
Chuck	380 mm (15 inch)	●	-
	450 mm (18 inch)	○	-
	530 mm (21 inch)	○	-
	610 mm (24 inch)	○	●
	810mm (32인치)	-	○
	NONE	○	○
Turret	8 st	○	-
	10 st	○	-
	12 st	●	●
	9 st + 1 Straddle tool	○	-
Coolant pump direction	Side	○	○
	Rear	●	●
Coolant pump	1.5 bar	●	-
	4.5 bar	○	●
	7 bar	○	○
	10 bar	○	○
	14.5 bar	○	○
	20 bar	○	○
	70 bar	-	○
Coolant options	High coolant interface	○	○
	Oil Skimmer(Belt type)	○	○
	Coolant chiller(circulation type)	○	○
	Coolant pressure switch	○	○
	Coolant level switch : Sensing level - Low	○	○
Chucking option	Dual pressure chucking	○	○
	Chuck clamp conrmation	●	●
Work location confirmation	Air limit sensor preparation _Festo	○	○
	Air limit sensor preparation _TACO	○	○
Workpiece measurement	Removable tool setter	○	○
	Auto tool setter(Electric)	○	○
	In-machine workpiece measuring system(Renishaw)	○	○
Jaw	Soft jaw	●	●
	Hardend & Ground hard jaws	○	○
Side chip conveyor	Hinged belt	○	○
	Magnetic scrapper	○	○
Rear chip conveyor	Hinged belt	○	○
	Magnetic scrapper	○	○
Chip processing options	Chip bucket	○	○
	Air blower	○	○
	Chuck Coolant	○	○
	Bed flushing Coolant	○	●
	Air Gun	○	○
	Coolant gun	○	○
	Mist collector_1.5kW (2.0Hp)	○	○
	Mist collector_2.2kW (3.0Hp)	○	○
Automatic configuration	Auto door with safety edge	○	○
	Automatic side door	○	○
	Work & Tool counter	○	○
	OP panel position check (Pandent arm position check)	○	○
	Autoomatic Tool Changer	○	○
Robot Interface	PMC I/O MODULE TYPE	○	○
	PROFIBUS-DP TYPE	○	○
Optional devices	Tool load mononitoring system	●	●
	Signal tower	○	○
	Additional MPG	○	○
	Straddle tool preparation (PV 8300L/R, PV 8300-2SP only)	○	X
	Linear scale (X-axis)	○	○
	Linear scale (Z-axis)	-	○
	Auto power off	○	○
	Quick change tooling(CAPTO)	○	○
OP Panel type	Pendant arm	●	●
	Base mount	○	○
Customized Special Option	Coolant Tank_High Capacity_500L	○	-
	Rotary Type Window Wiper_Eletrical	○	-
	Chip Coveyor_Drum Filter Type	○	○
	Raised Column_200Mm	○	○
	Chuck Type_4 Jaw_T-Slot	○	○
	Rotary Cylinder_For Air Limit Sensing	○	○
	Raised Level Plate_110 Mm	○	○
	Raised Level Plate_160 Mm	○	○
	Raised Level Plate_200 Mm	○	○
	Additional Hydraulic A/B Line	○	○
	ACCUMULATOR FOR HYDRAULIC POWER UNIT	○	○
	AIR BLOWER THROUGH TURRET_WITH COOLANT	○	○

Please contact your DN Solutions representative for detailed machine information.

● Standard ○ Optional X N/A



There is a high risk of fire when using non-water-soluble cutting fluids, processing flammable materials, neglecting the controlled and careful use of coolants and modifying the machine without the consent of the manufacturer. Always check the SAFETY GUIDELINES carefully before using the machine.

PERIPHERAL EQUIPMENT

Chip conveyor OPTION



Long

Short



Needle

Sludge

Hinged belt type*

Most common type of chip conveyor. Appropriate for steel materials generating chips over 30mm (1.2inch).

Drum filter type**

Chip conveyor with a magnet. Appropriate for machining cast iron and the generation of fine chips.

Chip conveyor type	Material	Carbon steel)			Cast iron		Aluminium		
		Long	Short	Needle	Short	Sludge	Long	Short	Needle
Hinged belt type*		○	△	X	△	X	○	△	X
Scraper type	Normal	X	○	△	○	△	X	△	X
	Magnetic	X	○	○	○	○	-	-	-
Drum filter type**	Hinged type	○	△	X	△	X	○	△	X
	Scraper	X	○	△	○	△	X	○	△

○ : Suitable, △ : Possible, X : Not suitable

Servo straddle tool OPTION

Simultaneous dual side cutting for higher productivity.
(Only for PV 8300L/R, PV 8300-2SP only)

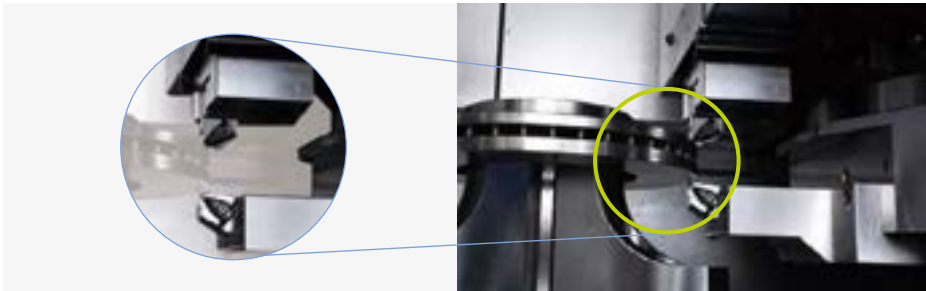

Quick change CAPTO OPTION

The quick change tool system simplifies tool change operations. It is recommended for users who need to a) change tools frequently or b) reduce set-up times.



Auto side door OPTION

Automatic side door enables the machine to become automated.



Detachable tool setter OPTION

The tool setter facilitates the setting of cutting tools, and can be used to detect worn tools.



Axis-tool number display OPTION

Axis-tool 'Number Display' is located inside the machine and it displays real time information to the operator.



Auto Tool Setter OPTION

Tool measurement for initial setting and worn tool length compensation can proceed without manual work or machine stop



Coolant chiller (recommended) OPTION

A coolant chiller is recommended to help prevent temperature rises and to reduce thermal deformation when using a water-insoluble coolant or high-pressure coolant system (i.e., power over 1.5kW).

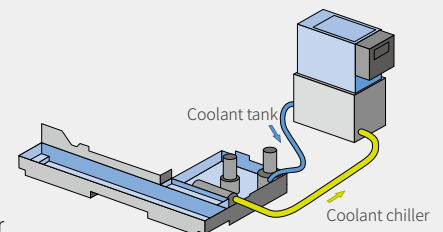

DN SOLUTIONS FANUC i PLUS

DN Solutions Fanuc i Plus maximizes customer productivity and convenience.

15" Screen + New OP

DN Solutions Fanuc i Plus' operation panel enhances operating convenience by incorporating common-design buttons and layout. It features a Qwerty keyboard for fast and easy data input and operation.

DN Solutions Fanuc i Plus

- 15-inch color display
- Intuitive and user-friendly design

USB and PCMCIA card QWERTY keyboard

- EZ-Guide i standard
- Ergonomic operator panel
- 2MB Memory
- Hot keys



iHMI touchscreen OPTION

iHMI provides an intuitive interface that uses a touchscreen for quick and easy operation.

Range of applications

Providing various applications related to planning, machining, improvement and utility, for customer convenience.

NUMERIC CONTROL SPECIFICATIONS

FANUC

Division	Item	Specifications	2-axis	M	2SP	M-2SP
			DN Solutions Fanuc i Plus	DN Solutions Fanuc i Plus	DN Solutions Fanuc i Plus	DN Solutions Fanuc i Plus
Controlled axis	Controlled axes		2 (X,Z)	3 (X,Z,C)	4 (X1,Z1+X2,Z2)	6 (X1,Z1,C1+X2,Z2,C2)
	Simultaneously controlled axes		2 axes	3 axes	2 axes (each path)	3 axes (each path)
Data input/output	Fast data server		○	○	○	○
	Memory card input/output		●	●	●	●
	USB memory input/output		●	●	●	●
	Larger capacity memory_2GB	Note *2) Available Option only with 15" Touch LCD (iHMI Only)	○ *2)	○ *2)	○ *2)	○ *2)
Interface function	Embedded Ethernet		●	●	●	●
	Fast Ethernet		○	○	○	○
	Enhanced Embedded Ethernet function		●	●	●	●
Operation	DNC operation	Included in RS232C interface.	●	●	●	●
	DNC operation with memory card		●	●	●	●
Program input	Workpiece coordinate system	G52 - G59	●	●	●	●
Feed function	AI contour control I	G5.1 Q_, 40 Blocks	●	●	●	●
	AI contour control II	G5.1 Q_, 200 Blocks	○	○	○	○
Operation Guidance Function	EZ Guidei (Conversational Programming Solution)		●	●	●	●
	iHMI with Machining Cycle	Note *1) Only with 15" Touch LCD standard	○ *1)	○ *1)	○ *1)	○ *1)
	Multi path function	Supporting 2 or 3 path machine	●	●	●	●
Setting and display	EZ WORK		●	●	●	●
	CNC screen dual display function		●	●	●	●
Network	FANUC MTConnect		✱	✱	✱	✱
	FANUC OPC UA		✱	✱	✱	✱
Others	Display unit	15" color LCD	●	●	●	●
		15" color LCD with Touch Panel	○	○	○	○
	Part program storage size & Number of registerable programs	5120M(2MB)_1000 programs	●	●	●	●

Network: FANUC MTConnect and FANUC OPC UA available.

● Standard ○ Optional X N/A ✱ Available

CONVENIENT OPERATION

SIEMENS S828D

15. inch display + New OP

Siemens 828D' operation panel enhances operating convenience by incorporating common-design buttons and layout. It features a Qwerty keyboard for fast and easy data input and operation.

- 15.6 inch display

- USB (standard)
- QWERTY keyboard



Convenient conversational functionality

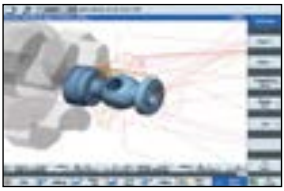

Shop-turn mode
[various]
↓
[attachments]

Cutting and operation support function

This function shows a cutting and tool path simulation in real-time.

The automation elements (parts catcher, parts unloader etc.), can be easily controlled via interactive screens.



[Custom]
↓
[Protection zones]



[offset]
↓
[operating parameter]
↓
[TC service]

Operation safety function

Protection Zone Synchronized Actions checks the interference between the turret and the spindle to prevent collisions caused by operator error.

Maintenance and service convenience function

Maintenance and service of major equipment and peripheral devices, including the timer and parts counter settings can be easily undertaken.

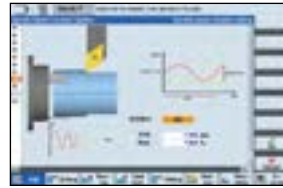

[various]
↓
[attachment]
↓
[DSSV]

Machining accuracy improvement

The NC controls spindle speed at an optimal level for precision threading and turning, making it possible to automatically improve surface roughness.



Before applying the function

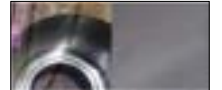

After applying the function

NUMERIC CONTROL SPECIFICATIONS

SIEMENS

Division	Item	Specifications	2-Axis		M		2SP, M-2SP	
			S828D	S840D	S828D	S840D	S828D	S840D
Controlled axis	Controlled axes		X,Z,SP		X,Z,C,R		X,Z,C,C2,B	
	Simultaneously controlled axes		4 axes	4 axes	4 axes	4 axes	4 axes	4 axes
Data input/output	Memory card input/output		X	X	X	X	X	X
	USB memory input/output		●	●	●	●	●	●
Interface function	Ethernet	(X130)	○	●	○	●	○	●
	On network drive	(without EES option, Extcall)	○	●	○	●	○	●
Operation	On USB storage medium, e.g. memory stick	(without EES option, Extcall)	●	●	●	●	●	●
Program input	Workpiece coordinate system	G54 - G59, G507 - G599	●	●	●	●	●	●
Feed function	Advanced surface		X	X	X	●	X	X
	Top surface		X	X	X	X	X	X
	Look ahead number of block		1	1000	1	1000	1	1000
Programming & Editing function	3D simulation, finished part		●	●	●	●	●	●
	Simultaneous recording		●	●	●	●	●	●
	DXF Reader for PC integrated in SINUMERIK Operate		○	○	○	○	○	○
Operation Guidance Function	Shopturn		●	●	●	●	●	●
	EZ Operation package		●	●	●	●	●	●
Setting and display	Operation via a VNC viewer		●	●	●	●	●	●
	MTConnect		✱	✱	✱	✱	✱	✱
Network	OPCUA		○	○	○	○	○	○
	Display unit	15.6" color display with touch screen	●	●	●	●	●	●
Others	Part program storage size	CNC user memory 10 MB	●	●	●	●	●	●
		CNC user memory 100 MB	○	○	○	○	○	○
		CNC user memory 6GB	X	○	X	○	X	○
		CNC user memory 40GB (with PCU or IPC)	X	○	X	○	X	○
		CNC user memory without limit (Execution from external storage devices) (EES / Using by USB or Network)	○	○	○	○	○	○
		HMI user memory for CNC part program 6GB	X	○	X	●	X	○

● Standard ○ Optional X N/A ✱ Available

POWER | TORQUE

FANUC

PV 8300 / M , Gear box

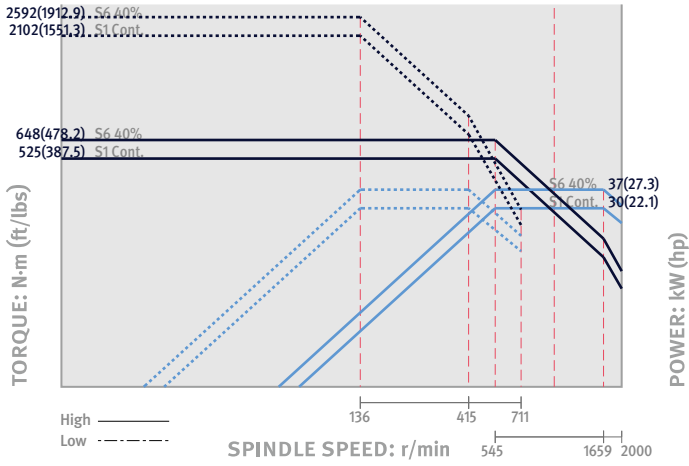

PV 8300 / M , Gear box OPTION 1

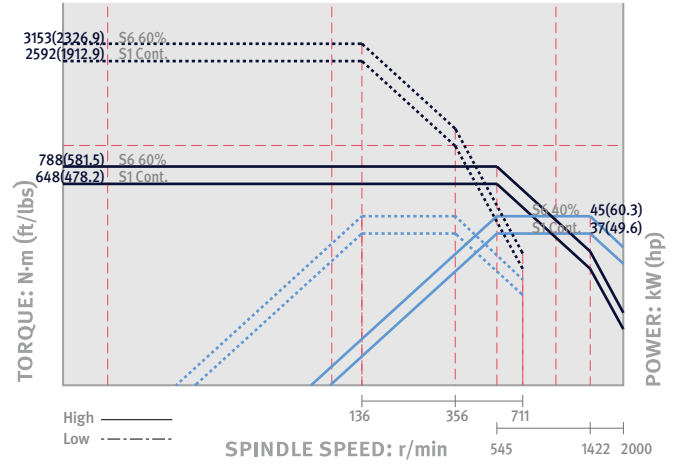

PV 8300 OPTION 2

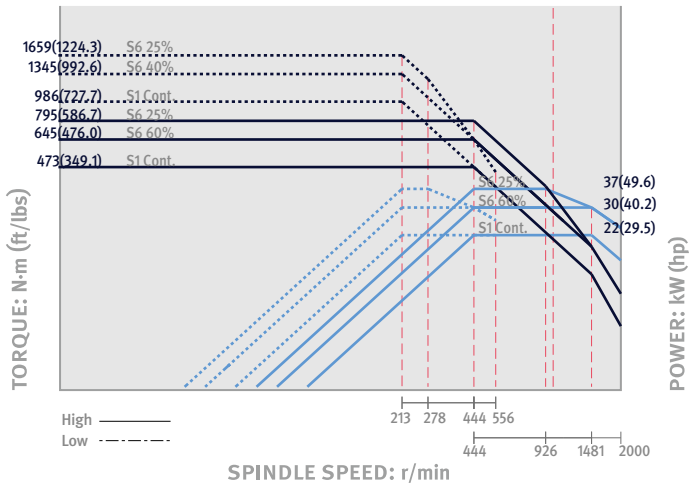

PV 8300 M OPTION 2

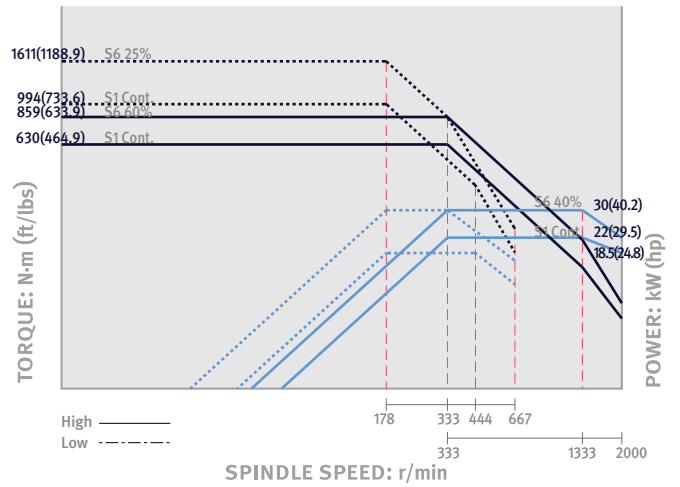

Rotary Tool

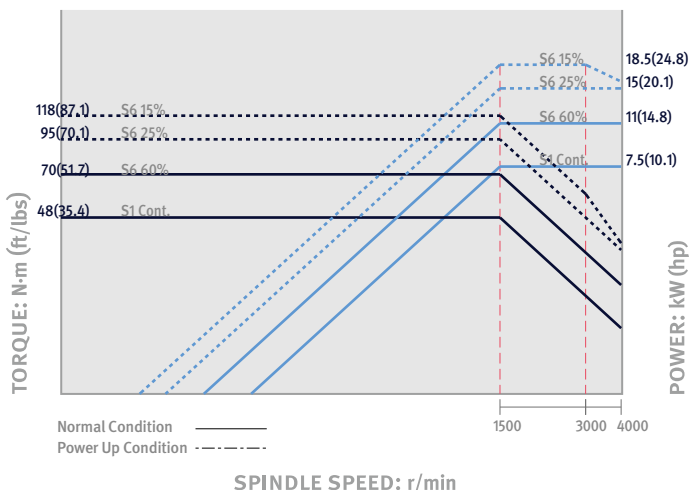

POWER | TORQUE

FANUC

PV 9300M

Max. spindle speed : **1800** r/min
 Max. power : **45/37** kW
 60.3/49.6 Hp
 Max. torque : **4444** N·m
 3279.7 ft-lbs

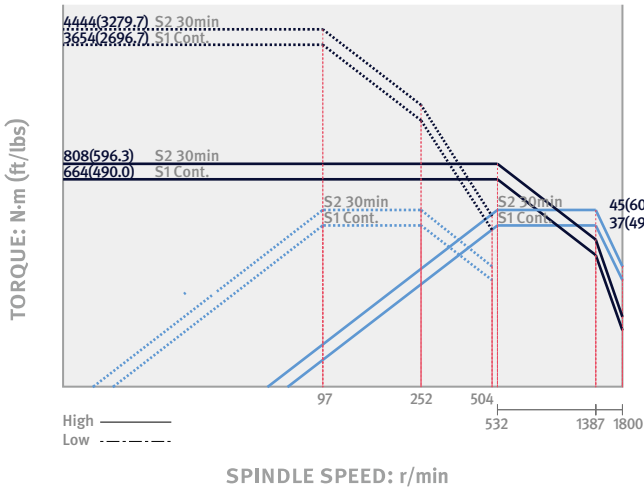

Rotary Tool_PV 9300M

Max speed of live tool : **4000** r/min
 Max power of live tool : **23** kW
 30.8 Hp
 Max. torque : **146** N·m
 107.7 ft-lbs

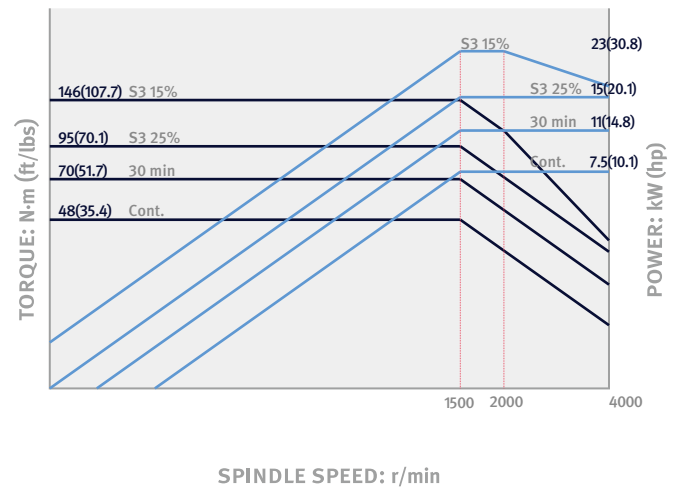

SIEMENS

PV 8300 / M

Max. spindle speed : **2000** r/min
 Max. power : **42/32/28** kW
 56.3/42.9/37.5 Hp
 Max. torque : **3376** N·m
 2491.9 ft-lbs

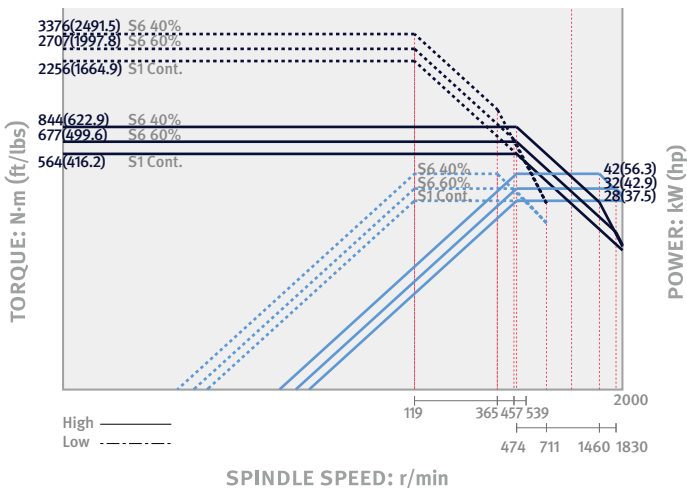

Rotary Tool_PV 8300M

Max speed of live tool : **4000** r/min
 Max power of live tool : **19.9** kW
 26.7 Hp
 Max. torque : **120** N·m
 88.6 ft-lbs

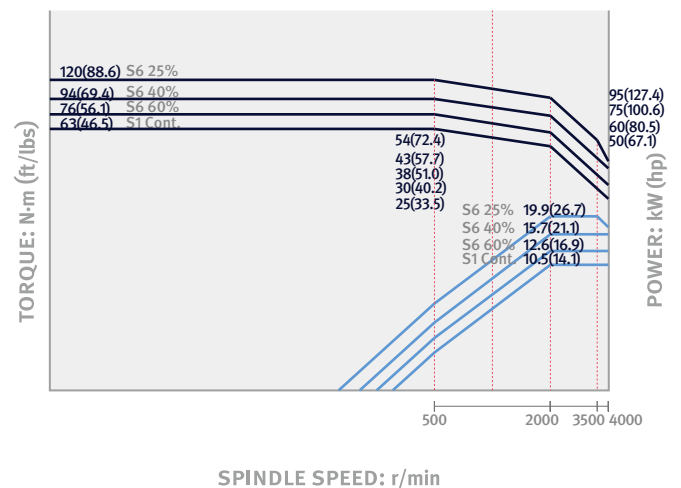

EXTERNAL DIMENSIONS

PV 8300/M (R type)

Unit : mm (inch)

TOP

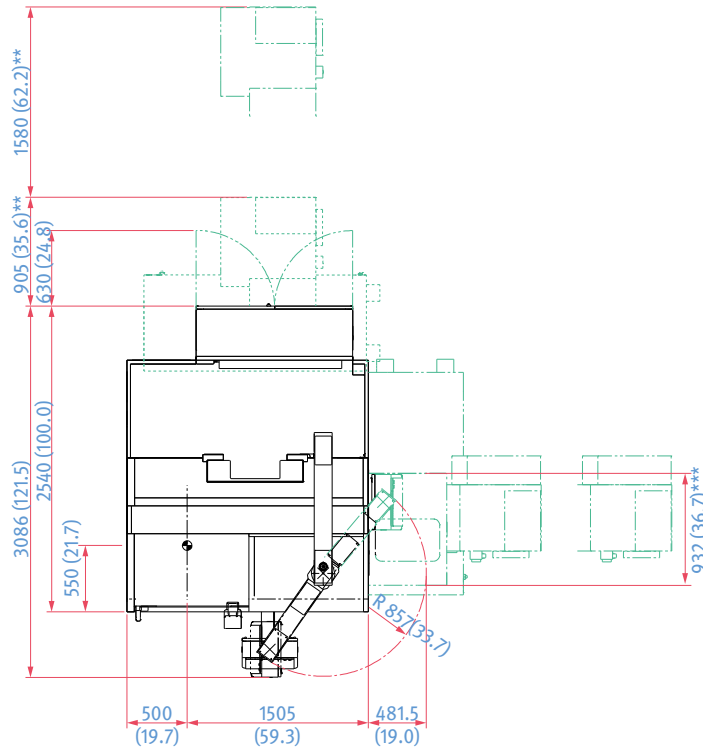

FRONT

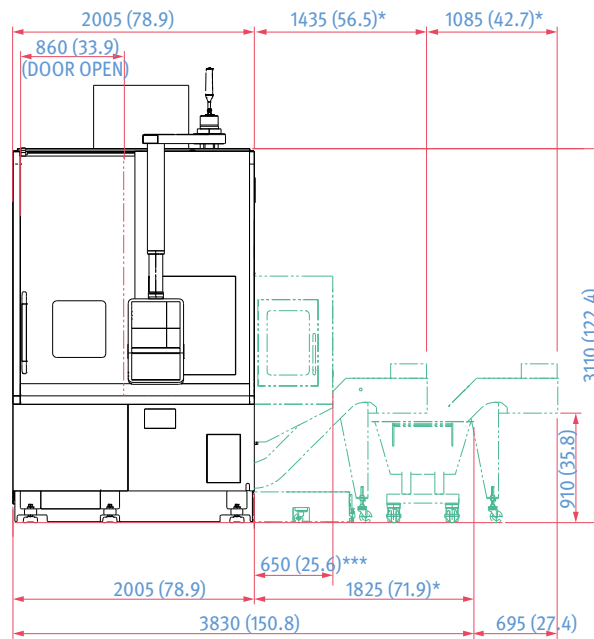

* Area for side chip conveyor
 ** Area for rear chip conveyor
 *** Area for Auto Tool Changer

* Some peripheral equipment can be placed in other areas.

EXTERNAL DIMENSIONS

PV 8300 /M (L type)

Unit : mm (inch)

TOP

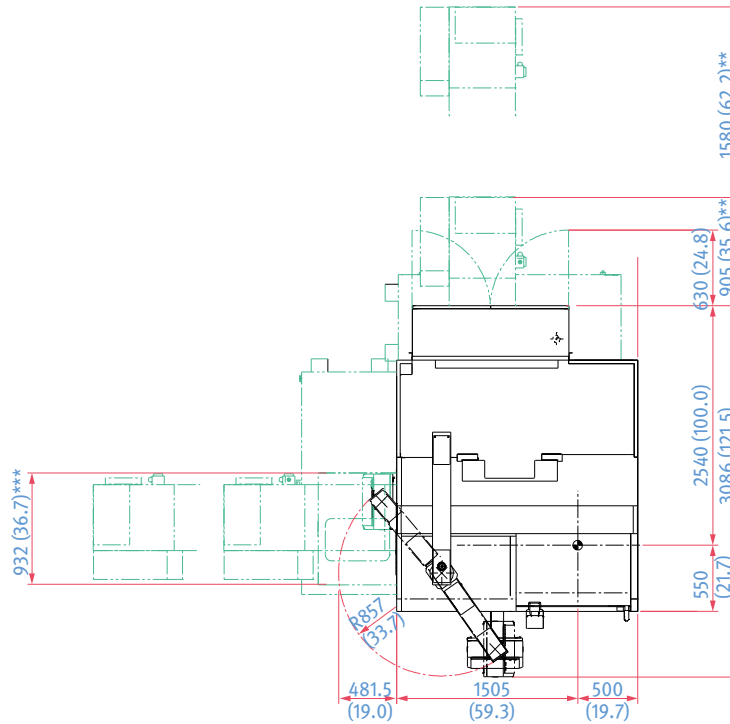

FRONT

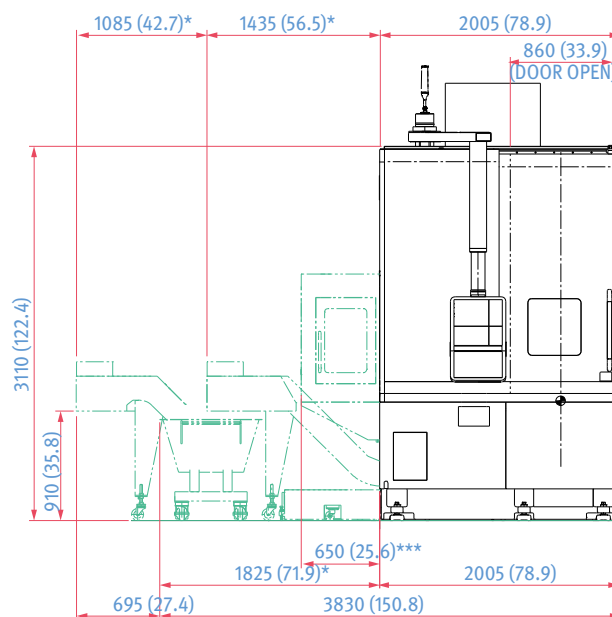

* Area for side chip conveyor
 ** Area for rear chip conveyor
 *** Area for Auto Tool Changer

EXTERNAL DIMENSIONS

PV 8300 /M-2SP

Unit : mm (inch)

TOP

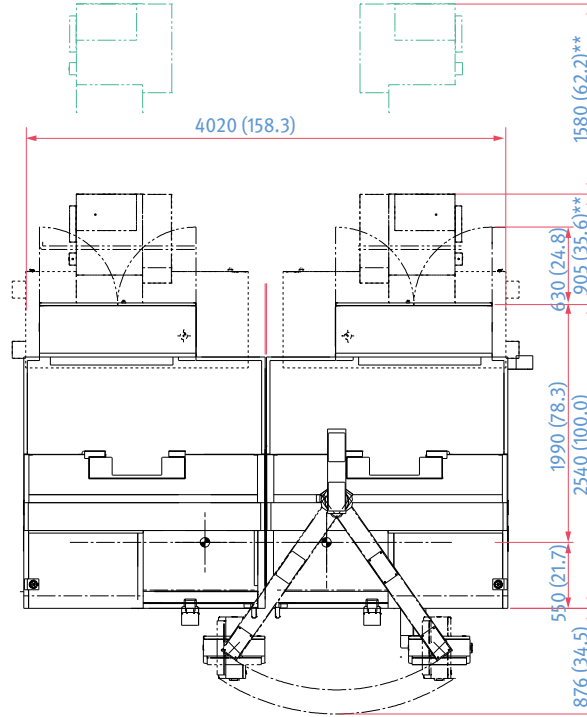

FRONT

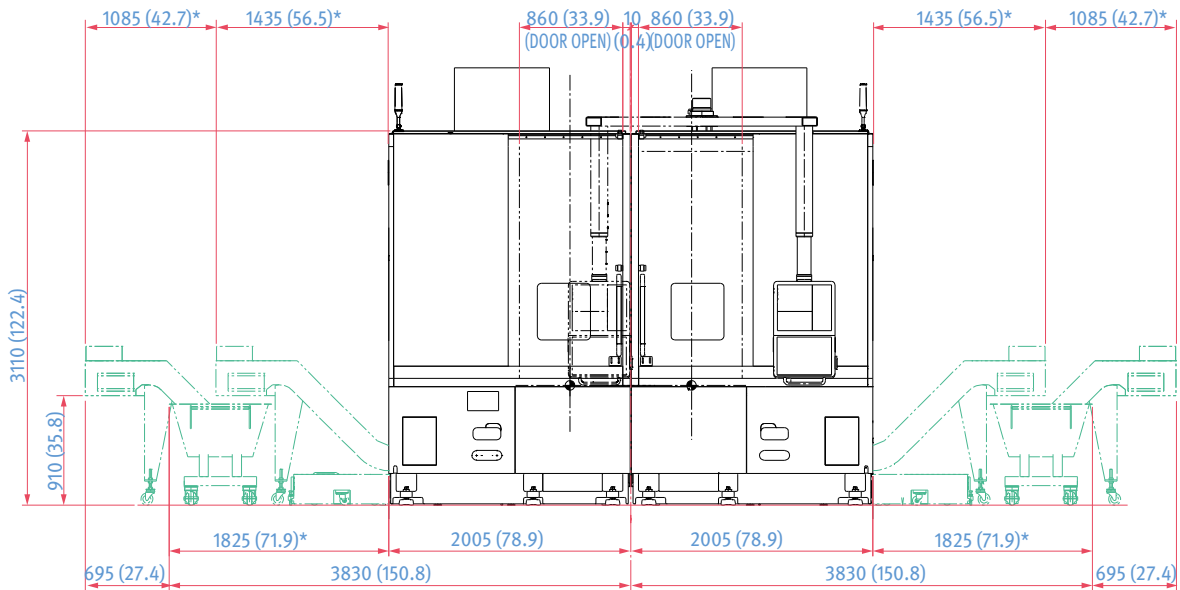

* Area for side chip conveyor
 ** Area for rear chip conveyor

* Some peripheral equipment can be placed in other areas.

EXTERNAL DIMENSIONS

PV 9300/M _L type

Unit : mm (inch)

TOP

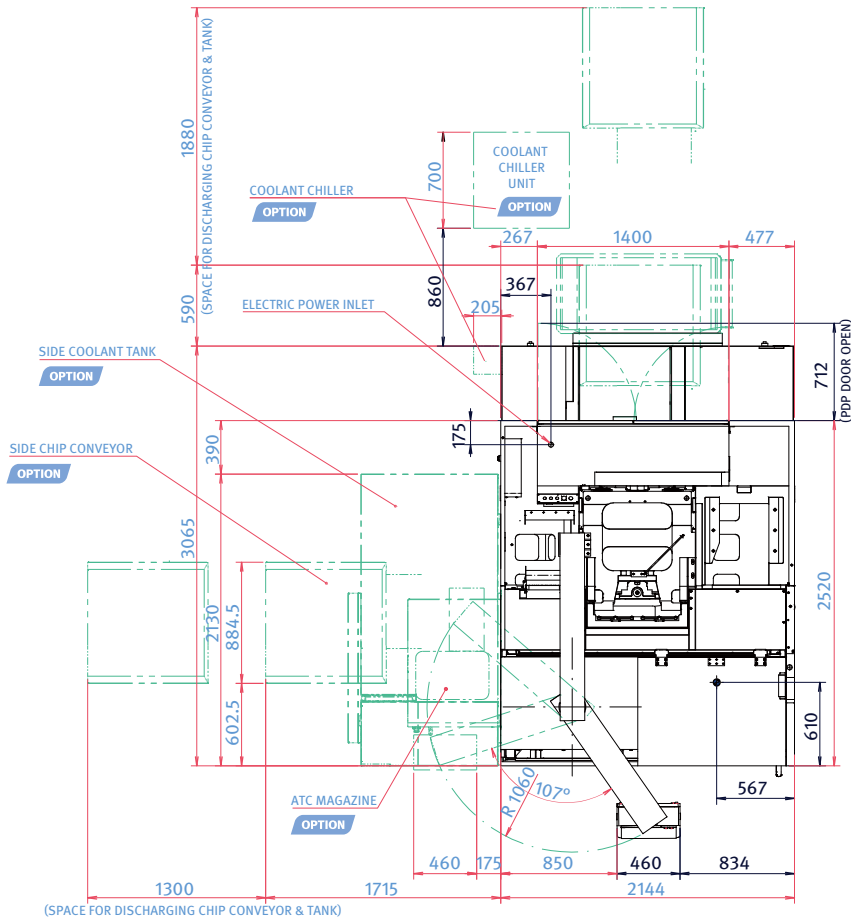

FRONT

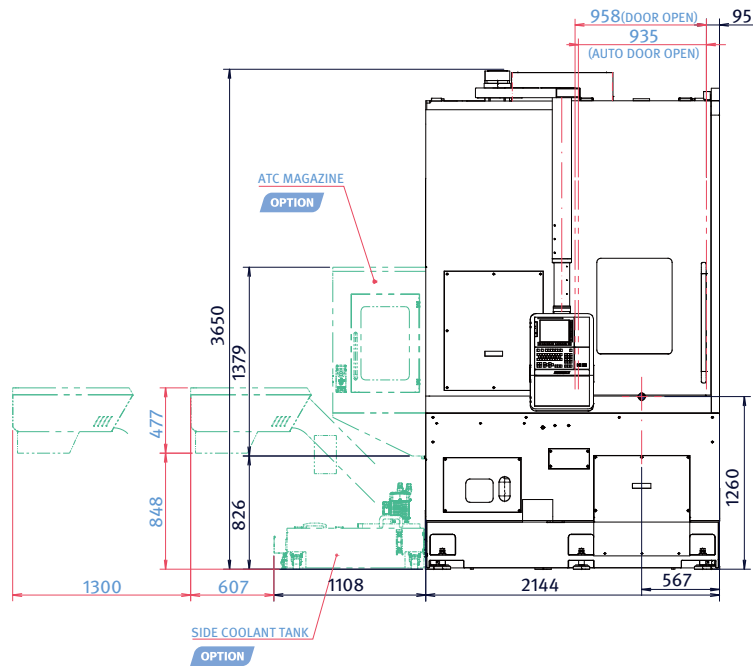

TOOLING SYSTEM

Unit : mm (inch)

PV 8300

Standard

() 12 ST

() 10ST

() 8ST

* () Supply quantity

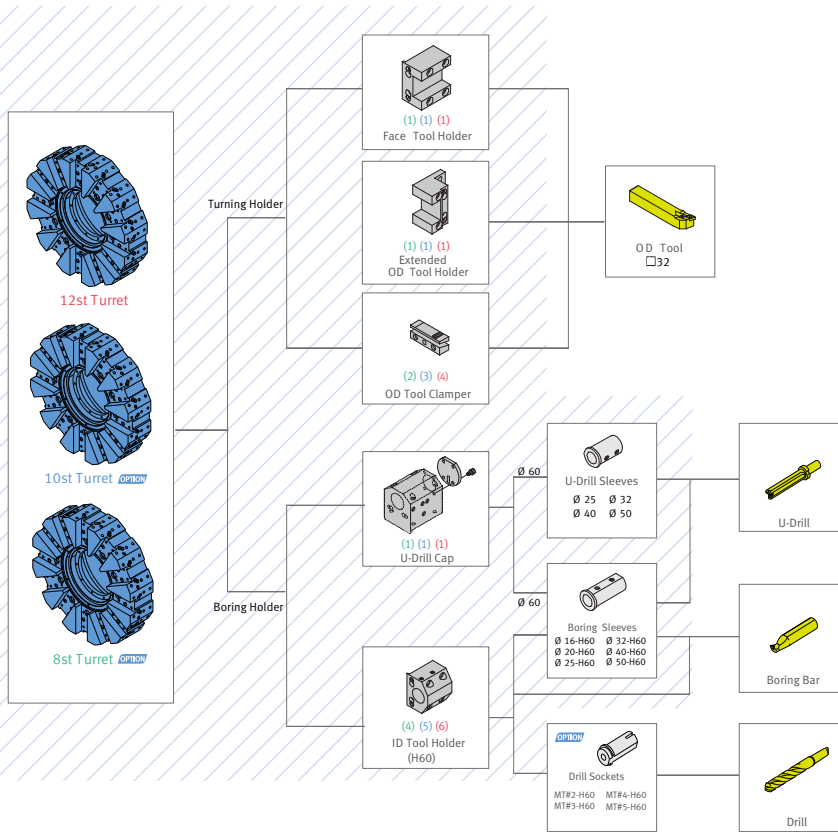

PV 8300 M

Standard

* () Supply quantity

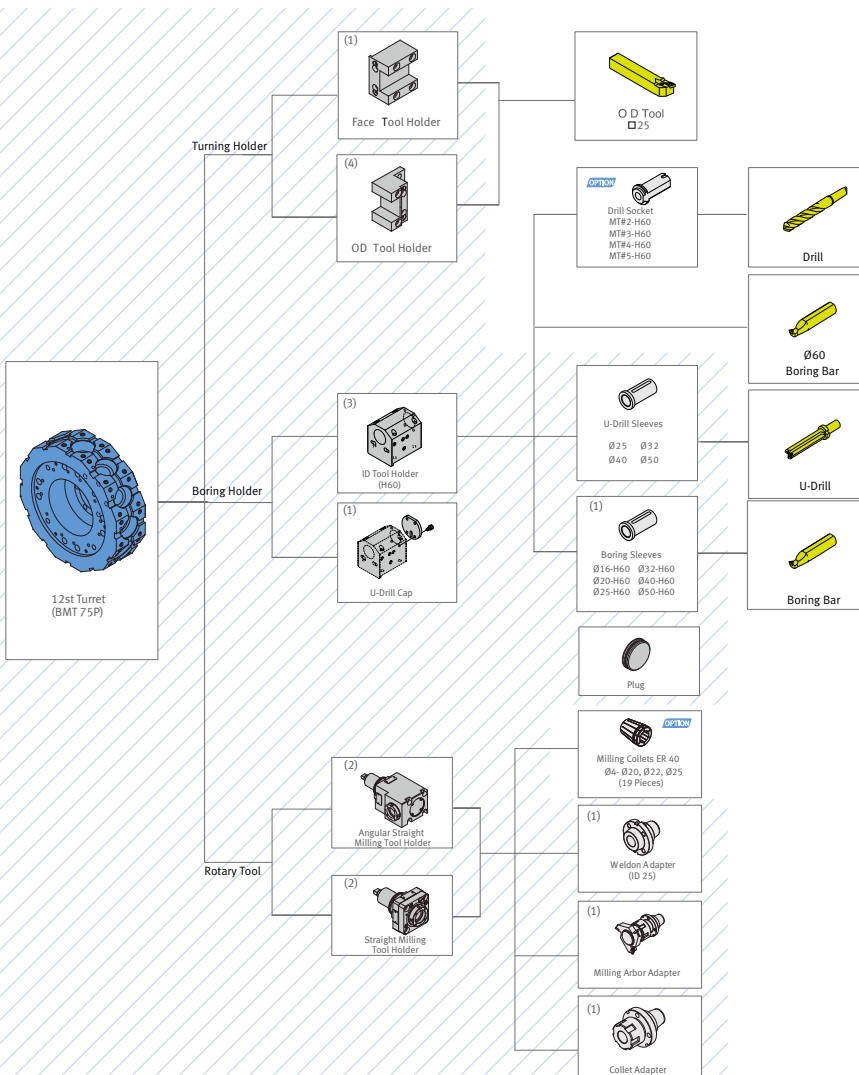

TOOL INTERFACE

Unit : mm (inch)

PV 9300

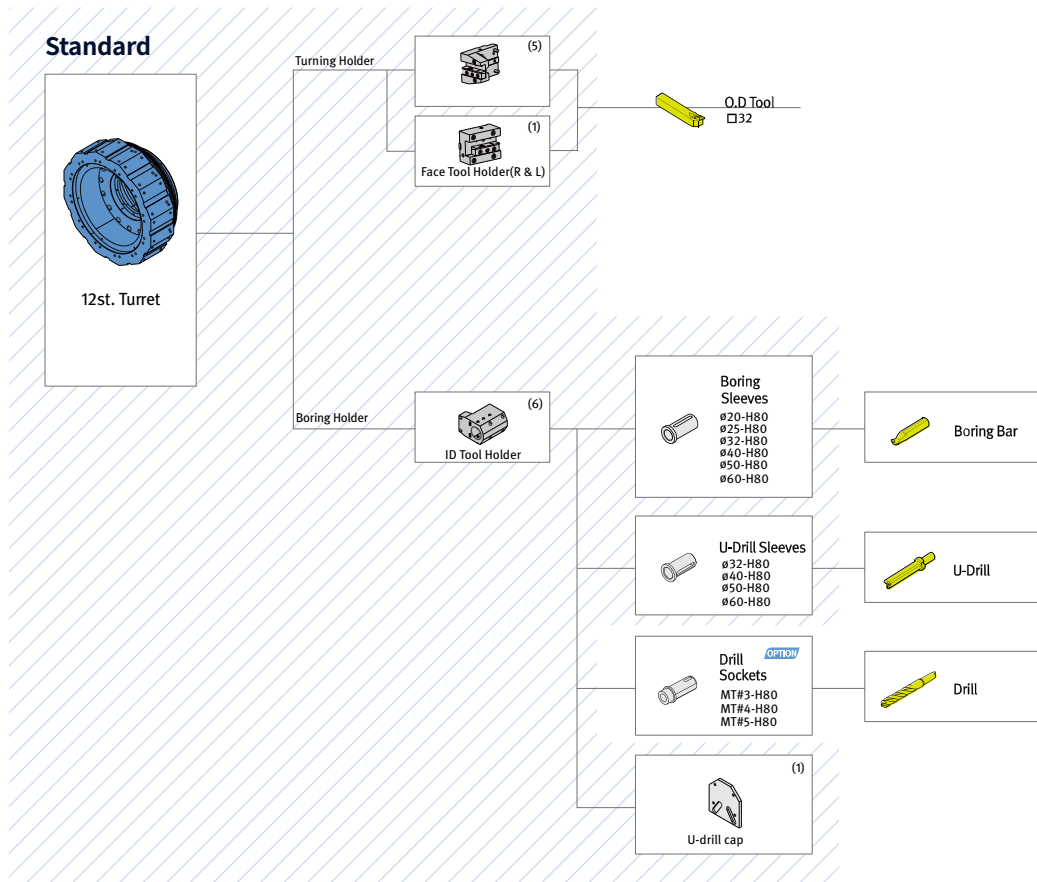

PV 9300M

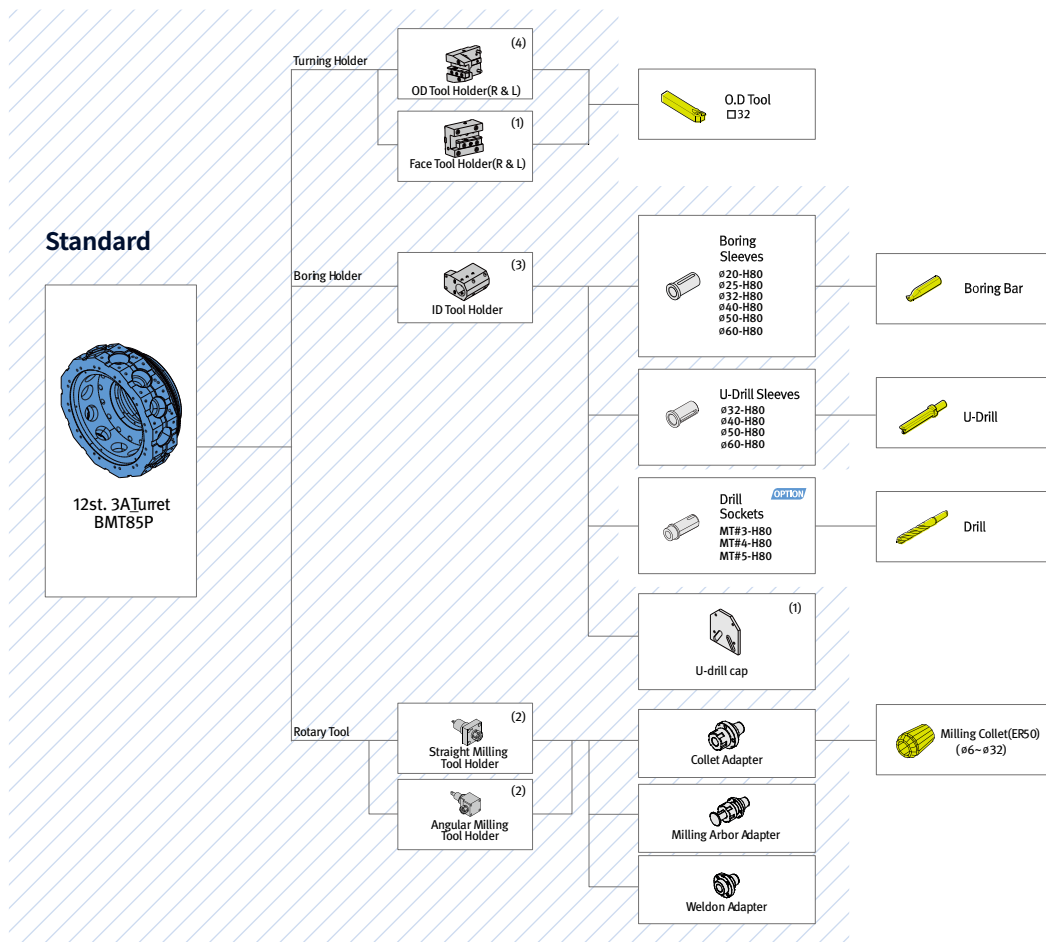

TOOL INTERFACE

PV 8300 (2-axis, 8st)

Unit : mm (inch)

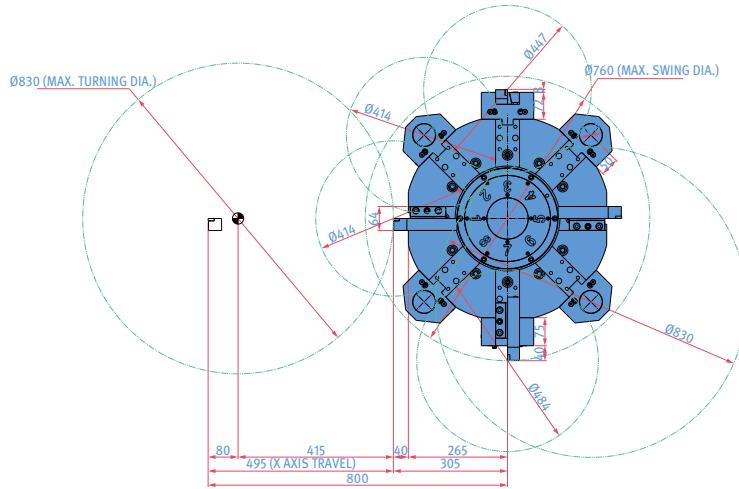

PV 8300 M (2-axis, 10st)

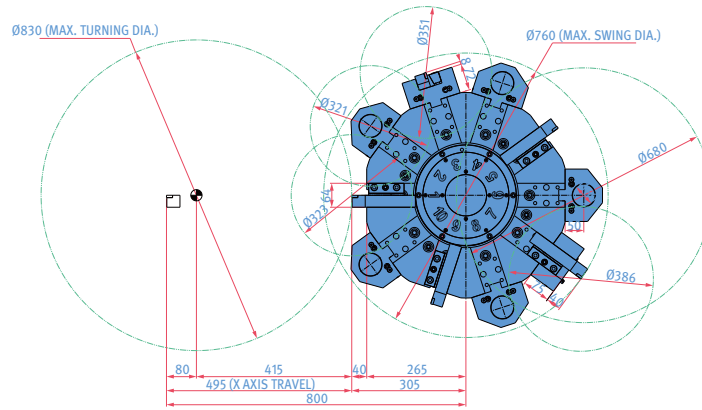

PV 8300 (2-axis, 12st)

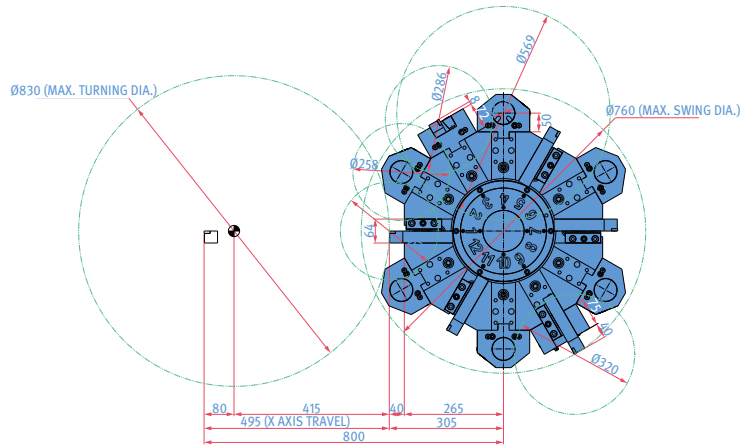

PV 8300 M (3-axis, 12st)

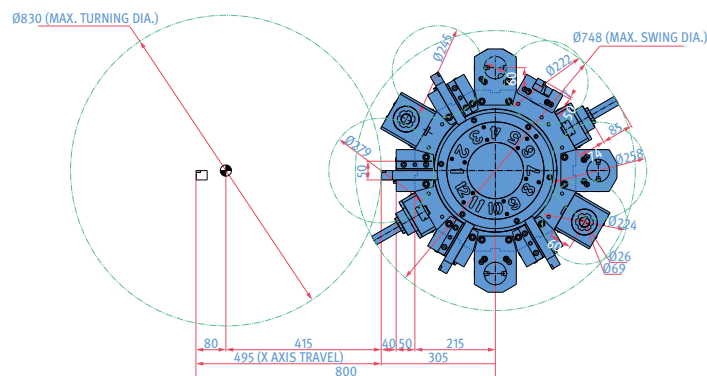

WORKING RANGE

PV 8300

Unit : mm (inch)

OD HOLDER

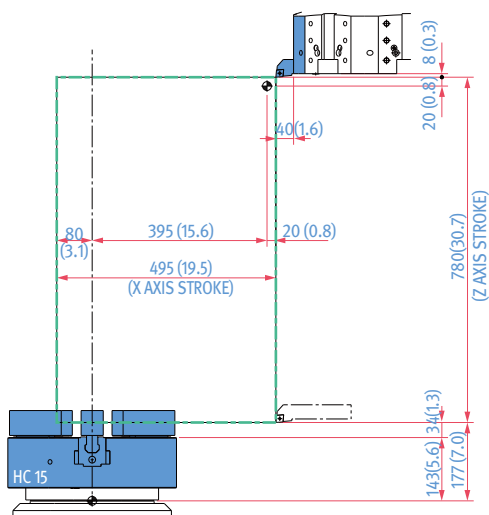

ID HOLDER

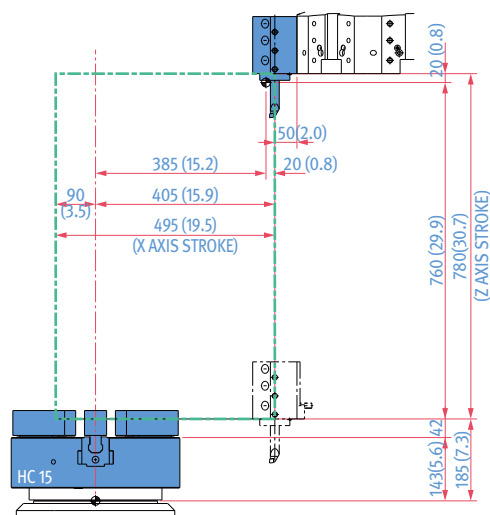

FACE TOOL HOLDER

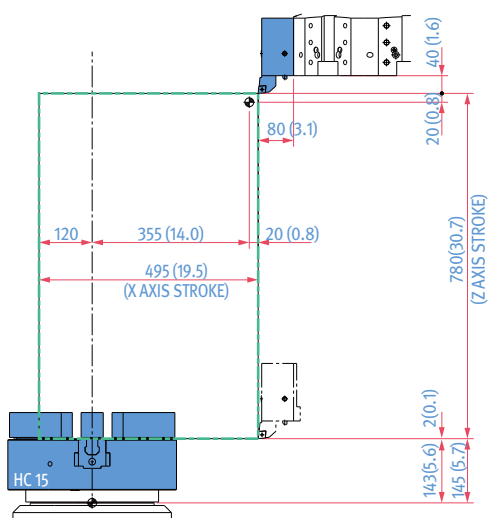

EXTENDED OD HOLDER

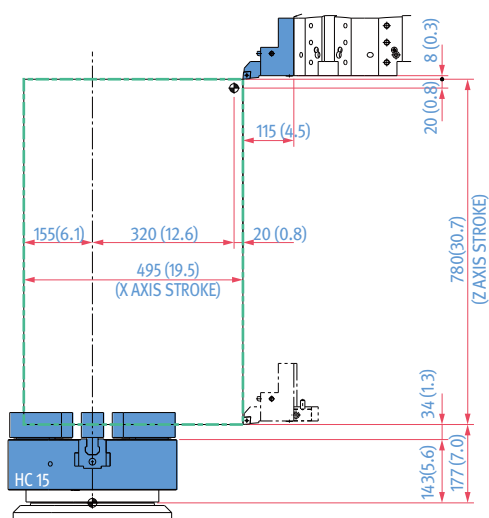

WORKING RANGE

PV 8300 M

Unit : mm (inch)

OD HOLDER

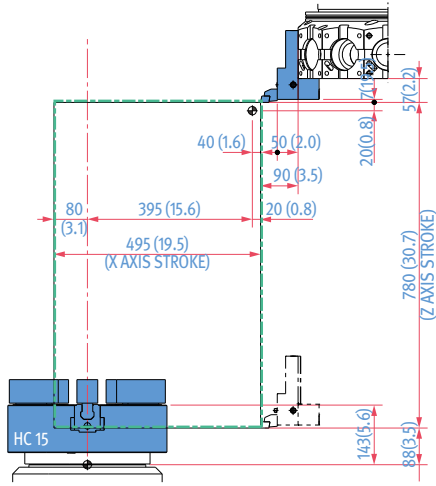

ID HOLDER

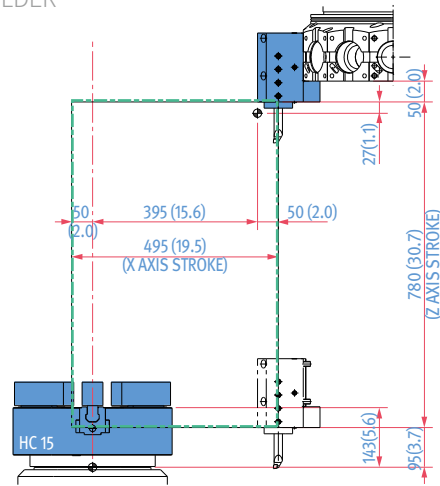

FACE TOOL HOLDER

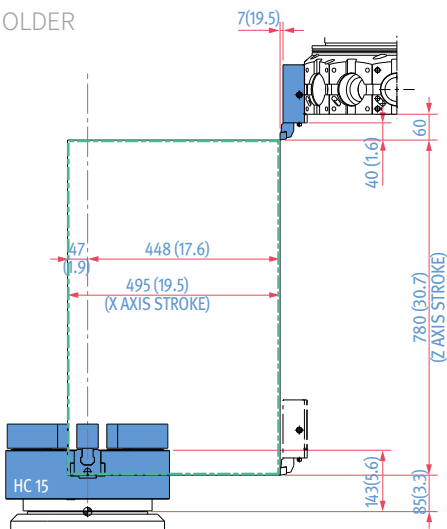

ANGULAR MILLING HOLDER

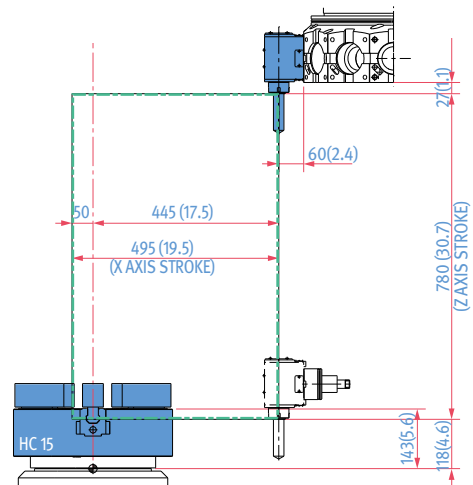

STRAIGHT MILLING HOLDER

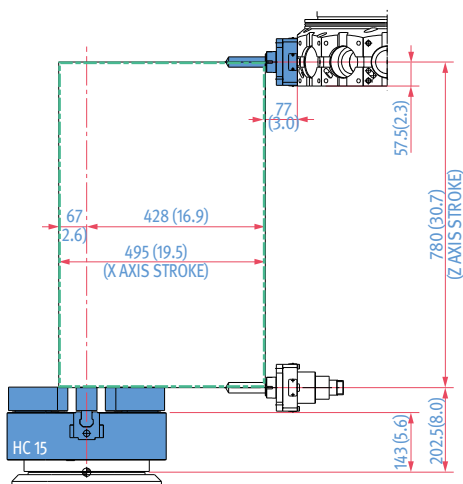

WORKING RANGE

PV 9300

Unit : mm (inch)

OD HOLDER

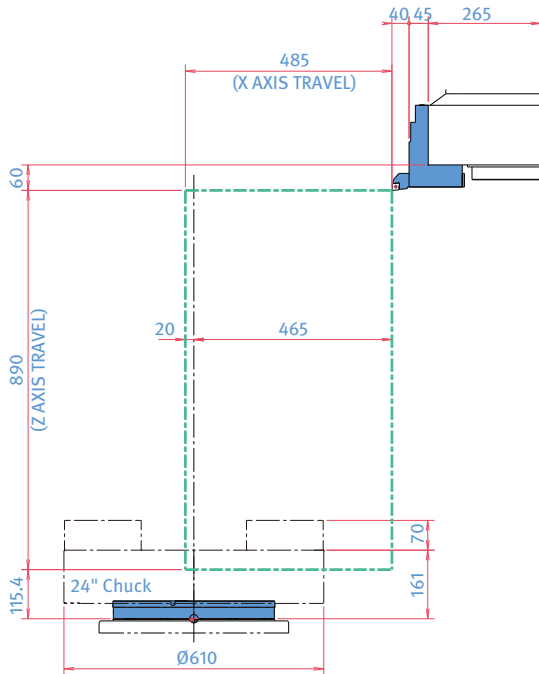

ID HOLDER

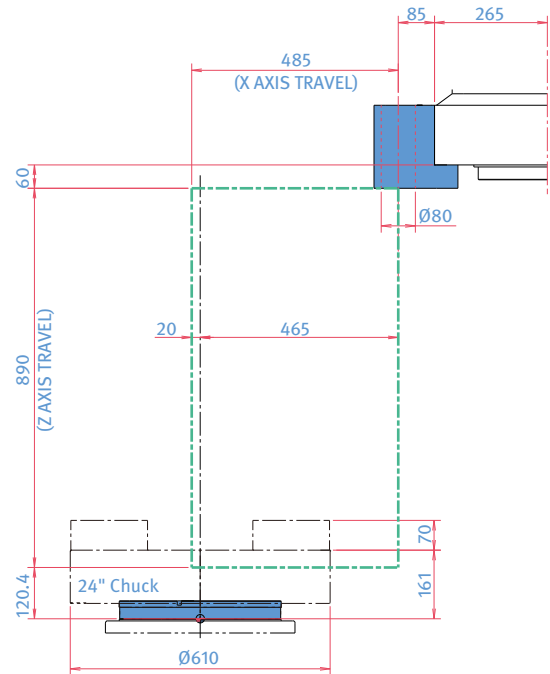

FACE TOOL HOLDER

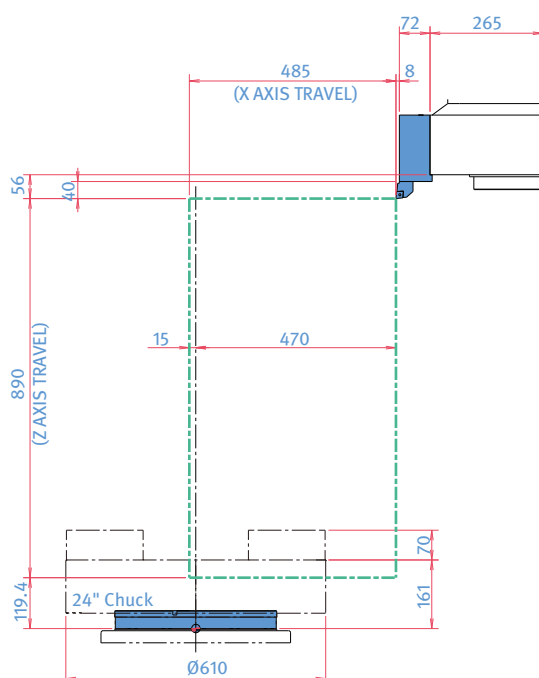

WORKING RANGE

PV 9300M

Unit : mm (inch)

OD HOLDER

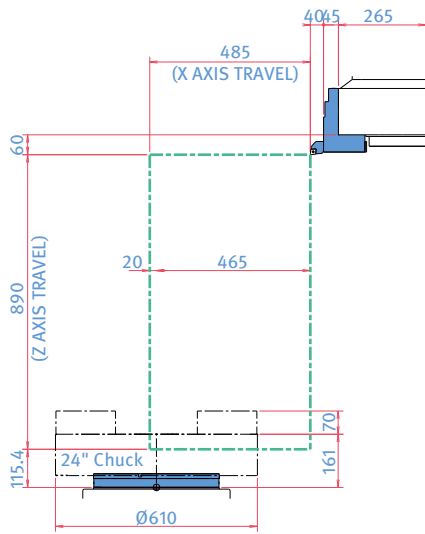

ID HOLDER

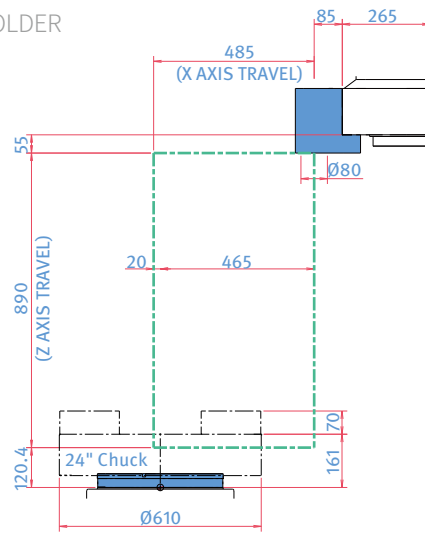

FACE TOOL HOLDER

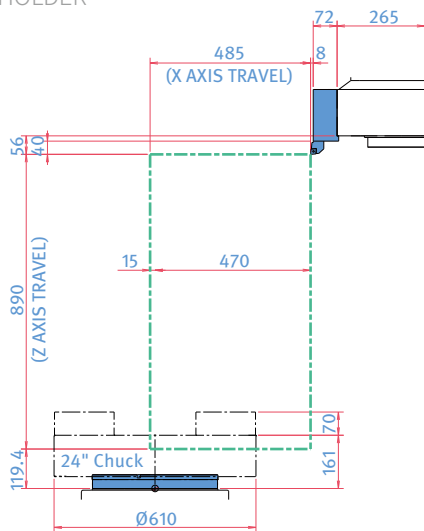

ANGULAR MILLING HOLDER

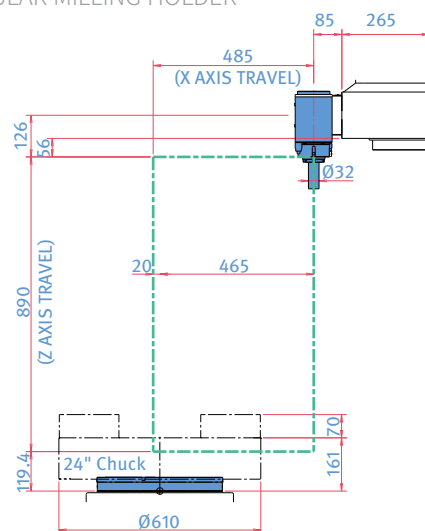

STRAIGHT MILLING HOLDER

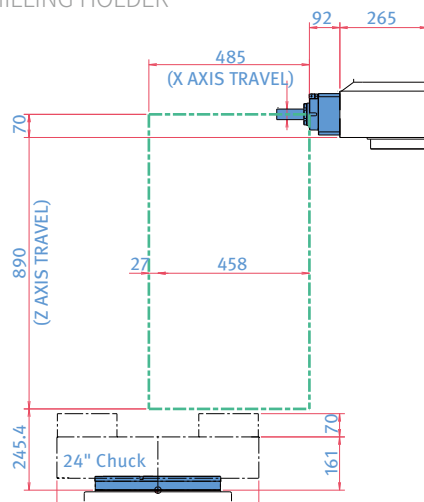

MACHINE SPECIFICATIONS

PV 8300 series

Description		Unit	PV 8300	PV 8300 M	PV 8300 -2SP	PV 8300 M-2SP
Capacity	Swing over bed	mm (inch)	920 (36.2)			
	Swing over saddle	mm (inch)	740 (29.1)			
	Max. workpiece swing	mm (inch)	850 (33.5)			
	Recommended turning diameter	mm (inch)	380 (15.0)			
	Max. turning diameter	mm (inch)	830 (32.7)			
	Max. turning length	mm (inch)	2 Axis : 780 (30.7) / 3 Axis : 690 (27.2)			
	Chuck size	inch	15 {18 / 21 / 24}*			
Travel	Travel distance	X-axis	495 (-80~415) (19.5(-3.1~16.3))			
		Z-axis	780 (30.7)			
Feedrate	Rapid traverse	X-axis	20 (787.4)			
		Z-axis	20 (787.4)			
Spindle	Spindle speed	r/min	2000			
	Spindle motor power (FANUC) (S6 40% / cont.)	kW (Hp)	37/30 {45/37, 37 /30/22 (S6 25%/ S6 60% Cont.)} (49.6/40.2 {60.3/ 49.6, 49.6/40.2/ 29.5})	37/30 {45/37, 30/22} (49.6/40.2 {60.3/ 49.6, 40.2/29.5})	37/30 {45/37, 37 /30/22 (S6 25%/ S6 60% Cont.)} (49.6/40.2 {60.3/ 49.6, 49.6/40.2/ 29.5})	37/30 {45/37, 30/22} (49.6/40.2 {60.3/ 49.6, 40.2/29.5})
	Spindle motor power (SIEMENS) (S6 40%/S6 60%/S1 Cont.)	kW (Hp)	42/32/28 (56.3/45.6/37.5)		-	
	Spindle motor torque (FANUC)	N · m (ft-lbs)	2592 {3153, 1659} (1912.9 {2326.9, 1224.3})	2592 {3153/1611} (1912.9 {2326.9, 1188.9})	2592 {3153, 1659} (1912.9 {2326.9, 1224.3})	2592 {3153/1611} (1912.9 {2326.9, 1188.9})
	Spindle motor torque (SIEMENS)	N · m (ft-lbs)	3376 (2491.5)		-	
	Spindel nose	ASA	A2-11			
	Spindle bearing diameter	mm (inch)	160 (6.3)			
	C-axis min.indexing angle	deg	-	0.001	-	0.001
Turret	No.of tool stations	ea	8 / 10 / 12			
	OD tool size	mm (inch)	32 x 32 (1.3 x 1.3)	25 x 25 (1.0 x 1.0)	32 x 32 (1.3 x 1.3)	25 x 25 (1.0 x 1.0)
	Turret indexing time(1st swivel)	sec	0.25			
	Max.rotary tool speed	r/min	-	4000	-	4000
	Ratary tool motor power (FANUC) (15% / cont)	kW (Hp)	-	18.5 / 7.5 (24.8/10.1)	-	18.5 / 7.5 (24.8/10.1)
	Ratary tool motor power (SIEMENS) (S6 25% / S6 40%/S6 60% / S1 Cont.)	kW (Hp)	-	19.9/15.7/12.6/10.5 (26.7/21.1/16.9/14.1)	-	-
Power source	Power consumption	kVA	61.78 {69.35, 54.13}		125.82 {141.22, 108.22}	
Machine dimensions	Length x Width	mm (inch)	2005 x 2715 (78.9 x 106.9)		4020 x 2715 (158.3 x 106.9)	
	Height	mm (inch)	3636 (143.1)			
	Weight	kg (lb)	9400 (20723.1)	9500 (20943.6)	18800 (41446.3)	19000 (41887.2)
Control	CNC system		DN Solutions Fanuc i Plus			

*{ } : option

MACHINE SPECIFICATIONS

PV 9300series

Description		Unit	PV 9300	PV 9300M	PV 9300-2SP	PV 9300M-2SP
Capacity	Swing over bed	mm (inch)	1000 (39.4)			
	Swing over saddle	mm (inch)	700 (27.6)			
	Recom. turning diameter	mm (inch)	610 (24.0)			
	Max. turning diameter	mm (inch)	930 (36.6)			
	Max. turning height	mm (inch)	801 (31.5)			
	Chuck size	inch	24 {32}			
Travel	Travel distance	X-axis	mm (inch)	485 (19.1)		
		Z-axis	mm (inch)	890 (35.0)		
	Rapid traverse Rate	X-axis	m/min(ipm)	20 (787.4)		
		Z-axis	m/min(ipm)	20 (787.4)		
Spindle	Max. spindle speed	r/min	1800			
	Motor power(S3 60%/cont.)	kW (Hp)	45/37 (60.3/49.6)			
	Max. spindle torque	N · m (ft-lbs)	4443 (3278.9)			
	Spindle nose	ASA	A2-15			
	Spindle bearing diameter	mm (inch)	200 (7.9)			
	Min. spindle Indexing angle(C-axis)	deg	-	0.001	-	0.001
Turret	No.of tool stations	ea	12			
	OD tool size	mm (inch)	32 (1.3)			
	Turret indexing time(1st swivel)	s	0.25			
	Max.rotary tool speed	r/min	-	4000	-	4000
	Ratary tool motor power (S3 15%/25%/60%/cont)	kW (Hp)	-	23/15/11/7.5 (30.8/20.1/14.8/10.1)	-	23/15/11/7.5 (30.8/20.1/14.8/10.1)
Power source	Power consumption	kVA	75.0		150	
Machine dimensions	Length x Width	mm (inch)	2144 x 3065 (84.4 x 120.7)	2144 x 3065 (84.4 x 120.7)	4288 x 3065 (168.8 x 120.7)	4294 x 3065 (169.1 x 120.7)
	Height	mm (inch)	3650 (143.7)			
	Weight	kg (lb)	11400 (25132.3)	11500 (25352.8)	22800 (50264.7)	23000 (50705.6)
Control	CNC system		DN Solutions-FANUC i Plus			



dn-solutions.com

Head Office

22F T Tower, 30, Sowol-ro 2-gil
Jung-gu, Seoul, Korea, 04637

Tel: +82-2-6972-0370/0350
Fax: +82-2-6972-0400

DN Solutions America

19A Chapin Road, Pine Brook
New Jersey 07058, United States

Tel: +1-973-618-2500
Fax: +1-973-618-2501

DN Solutions Europe

Emdener Strasse 24, D-41540
Dormagen, Germany

Tel: +49-2133-5067-100
Fax: +49-2133-5067-111

DN Solutions India

No.82, Jakkuar Village
Yelahanka Hobli, Bangalore-560064

Tel: + 91-80-2205-6900
E-mail: india@dncompany.com

DN Solutions China

Room 101,201,301, Building 39 Xinzhuan
Highway No.258 Songjiang District
China Shanghai (201612)

Tel: +86 21-5445-1155
Fax: +86 21-6405-1472

Sales inquiry

sales@dncompany.com

* For more details, please contact DN Solutions.

* Specifications and information contained within this catalogue may be changed without prior notice.